

LOCTITE®

**AUTOMOTIVE
AFTERMARKET
PRODUCTS
CATALOG**

VOLUME 9 – 2020

Henkel

PROFESSIONAL'S CHOICE

Professional technicians choose LOCTITE® products.

Turn to Henkel for professional grade products you can count on. The same products used on race cars around the world. The same products automotive manufacturers use to build the cars you repair. Why use anything else?

At Henkel we manufacture and market more than just quality products, we provide repair solutions. When we develop a LOCTITE® Automotive Aftermarket product, our primary thought is this: “The professional mechanic can only afford to do a job once!” Our products must work properly the first time, every time.











LOCTITE products have been reliably solving automotive maintenance and repair needs for over fifty years. Henkel invented the Threadlocking adhesive – a revolutionary method of positively locking and sealing threaded fasteners. When you buy our red bottles, you know you're getting an authentic LOCTITE product! And since the beginning, Henkel has constantly added new products with new capabilities that provide solutions to your problems.

In this catalog, you'll find everything you need to know about LOCTITE brand products for the Automotive Aftermarket and how they serve your application needs. The information is presented and grouped according to the product function (thread treatments, gasketing, adhesives, etc.) and includes product features, benefits, performance data, typical applications, selector guides, and package availability.

In addition to support from your local Henkel representative, this catalog is also supported by na.henkel-adhesives.com/aam – a virtual technical library designed to give you the best electronic support in the industry. Log on to the website to obtain additional technical information, such as material safety data sheets. To request product samples, application assistance, or the name of your nearest sales representative, call **1-855-436-5359**.



CONTENTS

	LOCTITE® Sticks	5
	Thread Treatments	6
	Threadlockers.....	7
	Thread Sealants.....	12
	Retaining Compounds	14
	Adhesives	16
	Gasketing	22
	Lubricants	30
	Specialty Products	34
	Product Application Guides	36-55
	Automobile Engine.....	36
	Diesel Engine.....	38
	Heavy-Duty Differential/Axle.....	40
	Automobile Transmission.....	42
	Heavy-Duty Transmission.....	44
	Heavy-Duty Suspension.....	46
	Motorcycle Chassis.....	48
	Motorcycle Engine.....	50
	Marine Inboard Engine.....	52
	Marine Outboard Engine.....	54
	Agency Approval Listings	56
	Product Index	58

LOCTITE® STICKS

No drips. No spills. No errors.

Henkel Corporation, the original inventor of anaerobic technology, now offers the same trusted performance in a solid stick formula. These patented stick products offer great flexibility for tough applications, especially overhead, and on components that cannot be moved. They're compact, making them easy to carry from job to job and easy to store in a toolbox, tool belt or pocket. The solid formula also means they won't spill or leak in toolboxes or on shop floors.



LOCTITE® THREAD TREATMENT STICKS KIT

One of our most significant innovations – SOLID formula LOCTITE® Thread Treatment Sticks. Now conveniently packaged in a kit designed to give you all five products in one part number. Upside down, right side up, or any angle in between, these sticks deliver!

Item	Container Size	Pack
576507	19–20 g sticks	5 Kits

KIT CONTAINS:

- 511535 LOCTITE® Red Stick Threadlocker (19 g)
- 504466 LOCTITE® Blue Stick Threadlocker (19 g)
- 504467 LOCTITE® Thread Sealant Stick (19 g)
- 504468 LOCTITE® Copper Anti-Seize Stick (20 g)
- 504469 LOCTITE® Silver Anti-Seize Stick (20 g)



LOCTITE® STICKS

LOCTITE® Blue Stick Threadlocker

Item Numbers 504466 / 506166
(See page 7)



LOCTITE® Red Stick Threadlocker

Item Numbers 511535 / 511537
(See page 7)



LOCTITE® Thread Sealant Stick

Item Number 504467
(See page 12)



LOCTITE® Copper Anti-Seize Stick

Item Number 504468
(See page 29)



LOCTITE® Silver Anti-Seize Stick

Item Number 504469
(See page 31)



LOCTITE® Hi-Tack Gasket Dressing Stick

Item Number 640807
(See page 24)



LOCTITE® Bearing Mount Stick

Item Number 640482
(See page 15)



LOCTITE® Disc Brake Quiet Stick

Item Number 718808
(See page 30)



THREAD TREATMENTS

You can't lose.

Henkel offers a full line of thread treatment products to suit the needs of the professional mechanic. Prevent loose fasteners and equipment failure with a few drops of a LOCTITE® threadlocker; fill the inner voids in press fits with LOCTITE® retaining compounds; use LOCTITE® anaerobic pipe or thread sealants to prevent leakage in metal fittings caused by vibration loosening, tape shredding, solvent evaporation and temperature cycling; and seal plastic and metal fittings with LOCTITE® non-hardening pipe joint compound.



THREADLOCKERS



LOCTITE® BLUE STICK THREADLOCKER

MEDIUM STRENGTH

This medium strength anaerobic threadlocker offers the same locking strength and sealing capabilities as our premier blue threadlocking liquid, LOCTITE® Threadlocker 243™. This wax-like stick is conveniently packaged in a self-feeding stick applicator. It is well-suited for difficult repairs, as in overhead applications. It can be applied to a part even if assembly is to take place at a later time, making the stick ideal for volume assembly. Removable with hand tools.

Typical Applications: Valve cover bolts, water pump bolts, oil pan bolts, drive shaft bolts, rocker arm adjustment nuts, carburetor studs.

Item	Container Size	Pack
506166	9 g	10
504466	19 g	6



LOCTITE® RED STICK THREADLOCKER

HIGH STRENGTH

With the same convenient packaging as the medium strength LOCTITE® Blue Stick Threadlocker, this high strength threadlocker is better suited for heavy-duty applications where resistance to heavy shock, vibration and stress levels is required. Localized heating and hand tools are required to separate parts.

Typical Applications: Assembly with air tools, cylinder block bolts, ring gear bolts, transmission shaft bolts.

Item	Container Size	Pack
511537	9 g	10
511535	19 g	6



LOCTITE® BLUE THREADLOCKER TAPE 249™

MEDIUM STRENGTH

The one and only threadlocker in a tape form. This revolutionary product offers the same reliability and performance as LOCTITE® removable grade threadlocking liquids.

Typical Applications: Valve cover bolts, water pump bolts, oil pan bolts, drive shaft bolts, rocker arm adjustment nuts, carburetor studs.

Item	Container Size	Pack
1372603	260 in. roll	10



LOCTITE® THREADLOCKER 222™

LOW STRENGTH

LOCTITE® Threadlocker 222™ is a low strength, purple threadlocker designed for fasteners under ¼" (6 mm) that require occasional adjustment.

Removable with hand tools for easy disassembly. Noncorrosive.

Typical Applications: Carburetors, relay locks, headlamps, throttle body assembly, choke assembly and fuel injection set screws, body panel mounting fasteners.

Item	Container Size	Pack
555339	6 ml tube	12



Invented by Henkel as a revolutionary method to positively lock and seal threaded fasteners, LOCTITE® threadlocker adhesives are used in a wide range of applications – from delicate fuel injection components to heavy-duty transmission and engine assemblies. Specified by automotive OEMs and approved for use on factory assembly lines, threadlockers work by filling the spaces between threads. The result is a secure, one-piece assembly that will not loosen under stress.

Available in varying strengths and temperatures, threadlockers perform reliably and effectively on fasteners of any type and size, either before or after assembly.

THREADLOCKERS



LOCTITE® THREADLOCKER 242® MEDIUM STRENGTH

LOCTITE® Threadlocker 242® is an all-purpose, medium strength, blue threadlocker. Ideal for all nut and bolt applications ¼" to ¾" (6 mm to 19 mm). Eliminates the need for stocking expensive lock nuts and lock washers. Locks and seals while preventing parts from loosening due to vibration. Protects threads from corrosion. Removable with hand tools for easy disassembly.



Typical Applications: Valve cover bolts, water pump bolts, oil pan bolts, drive shaft bolts, rocker arm adjustment nuts, carburetor studs.

Item	Container Size	Pack
487229	6 ml tube	12
492140	36 ml bottle	6



LOCTITE® THREADLOCKER 262™ HIGH STRENGTH

LOCTITE® Threadlocker 262™ is a permanent, high strength, red threadlocker that is applied to fasteners up to ¾" (19 mm) in size before assembly. Designed for securing parts that must withstand heavy shock, vibration, or extreme chemical or environmental conditions. Localized heating and hand tools are required to separate parts.



Typical Applications: Assembly with air tools, cylinder block bolts, ring gear bolts, transmission shaft bolts.

Item	Container Size	Pack
487231	6 ml tube	12
492141	36 ml bottle	6



LOCTITE® THREADLOCKER 243™ SURFACE INSENSITIVE-MEDIUM STRENGTH

A general-purpose, medium strength, primerless, blue threadlocker with improved oil tolerance. For fasteners between ¼" to ¾" (6 mm to 20 mm). Parts can be separated using hand tools.



Typical Applications: Rocker studs, rocker adjustment bolts, bolts on valve and cam covers, oil pans, disc brake calipers, intakes and alternators, and pulley assemblies.

Item	Container Size	Pack
1330799	6 ml tube	6
1330906	36 ml bottle	6



LOCTITE® THREADLOCKER 263™ SURFACE INSENSITIVE – HIGH STRENGTH

The most robust performing, high strength threadlocker available. A versatile, primerless, red threadlocker with excellent oil tolerance on as-received fasteners, up to 1" (25 mm). Cures consistently on a variety of metals including stainless steel and most plated fasteners. Localized heating required for disassembly.

Typical Applications: Assembly with air tools, cylinder block bolts, ring gear bolts, transmission shaft bolts, frame brackets, suspension fasteners.

Item	Container Size	Pack
2203451	6 ml tube	10
2205310	36 ml bottle	6

THREADLOCKERS



LOCTITE® THREADLOCKER 271™ HEAVY-DUTY

LOCTITE® Threadlocker 271™ is a high strength, red threadlocker for heavy-duty applications. Especially well-suited for permanently locking studs and press fits. Adds 3,000 psi holding power on slip and press fit assemblies. Replaces set screws and snap rings. Locks against vibration loosening. Removable with heat and hand tools. For fasteners up to 1" (25 mm) in size.



Typical Applications: Frame brackets, suspension fasteners, shock absorber mounts, wheel studs.

Item	Container Size	Pack
487232	6 ml tube	12
492142	36 ml bottle	6



LOCTITE® THREADLOCKER 277™ HEAVY-DUTY/LARGE BOLTS

LOCTITE® Threadlocker 277™ is a high strength adhesive for locking and sealing large bolts and studs 1" (25 mm) or larger in diameter. Heat may be required to weaken bond before parts can be disassembled.



Typical Applications: Frame brackets, suspension fasteners, shock absorber mounts, wheel studs.

Item	Container Size	Pack
555353	36 ml bottle	6



LOCTITE® THREADLOCKER 272™ HIGH TEMPERATURE

LOCTITE® Threadlocker 272™ withstands temperatures to 450°F. This high temperature/high strength, red threadlocker is formulated for heavy-duty applications. Prevents bolts up to 1-½" (38 mm) from loosening due to shock, severe vibration and heat stress. Exclusive formulation for newer engines and high performance applications where extreme temperature resistance is required. Removable with heat and hand tools.



Typical Applications: Camshaft sprocket bolts, crankshaft bolts, idler bearings, press fit filler tubes, transmission input and output shaft threads, ring gear and shock bolts.

Item	Container Size	Pack
492143	36 ml bottle	6



LOCTITE® THREADLOCKER 290™ PENETRATING

LOCTITE® Threadlocker 290™ is a low viscosity wicking grade, green, threadlocking liquid that wicks along the threads of pre-assembled fasteners to secure them in place. Since it is applied after assembly, preventive maintenance procedures are simplified. Ideal for fasteners ranging from #2 to ½" (2.2 mm to 12 mm) in size. Localized heating and hand tools are needed for disassembly.



Typical Applications: Bolts on alternators, air conditioning belts and distributor clamps, carburetor adjustment screws, and hairline cracks.

Item	Container Size	Pack
487234	6 ml tube	12
492144	36 ml bottle	6

THREADLOCKERS



LOCTITE® KLEAN N' PRIME ANAEROBIC PRIMER/ACTIVATOR

A solvent-based primer that features very long on-part life. Use to speed the cure of all LOCTITE® anaerobic products and ensure proper cure on inactive metals. Ideal for cure conditions below room temperature.



Typical Applications: All nut and bolt applications.

Item	Container Size	Pack
494147	4.5 oz. aerosol can	6

WHEN SHOULD I USE A PRIMER?

Use a primer when both surfaces are considered inactive. It is necessary to apply the primer to one surface, in most cases, unless gaps are excessive. See chart below.

ACTIVE METALS			
Iron	Plain Steel	<i>Kovar™</i>	Commercial Aluminum
Brass	Copper	<i>Monel™</i>	(with copper content e.g., 6061)
Bronze	Manganese	Nickel	
INACTIVE METALS			
Plated Parts	Pure Aluminum	Plastics	Natural or Chemical Black Oxide
Magnetite Steel	Titanium	Cadmium	Anodized Aluminum (ALODINE®, IRIDITE™)
Stainless Steel	Magnesium	<i>INCONEL™</i>	
Galvanized Steel	Gold and Silver	Zinc	

Low Strength Threadlockers



- Removable with hand tools
- Adjustment screws
- Calibration screws
- Meters and gauges
- Up to ¼" (6 mm) diameters

Medium Strength Threadlockers



- Removable with hand tools
- Machine tools and presses
- Pumps and compressors
- Mounting bolts
- Gear boxes
- Up to ¾" (19 mm) diameters

High Strength Threadlockers



- Removable with heat and hand tools
- Heavy equipment
- Suspension bolts
- Motor and pump mounts
- Bearing cap bolts and studs
- Up to 1" (25 mm) and larger diameters

Wicking Threadlockers



- Removable with heat and hand tools
- Preassembled fasteners
- Instrumentation screws
- Electrical connectors
- Carburetors
- Up to ½" (12 mm) diameters

THREADLOCKERS

PROPERTIES CHART: THREADLOCKERS

LOCTITE® PRODUCT	Item Number	Container	Typical Use	Color	Viscosity (cP)	Torque in. lbs. (M10 Steel Nuts & Bolts) Break/Prevail	Temp. Range	Cure Speed, Steel @ 25°C	Oil Tolerant	Agency Approvals
222™	555339	6 ml tube	Low strength up to ¼" (6 mm) screws	Purple	1,200/5,000 Thixotropic	53 / 30	-65°F - 300°F (-54°C - 149°C)	Fixture 10 min. — Full Cure 24 hrs.	•	•
242®	487229 492140	6 ml tube 36 ml bottle	Removable grade up to ¼" to ¾" (6 mm to 19 mm) bolts	Blue	1,200/5,000 Thixotropic	110 / 43	-65°F - 300°F (-54°C - 149°C)	Fixture 5 min. — Full Cure 24 hrs.	•	Mil-Spec (S-46163A) Type II, Grade N, CFIA
243™	1330799 1330906	6 ml tube 36 ml bottle	¼" to ¾" (6 mm to 19 mm) bolts with light oil contamination	Blue	2,250/12,000 Thixotropic	230 / 40	-65°F - 360°F (-54°C - 182°C)	Fixture 10 min. — Full Cure 24 hrs.	Yes	Agriculture Canada approved
249™	1372603	260" roll	¼" to ¾" (6 mm to 19 mm) bolts, overhead, pre-dispensed, hard-to-reach areas	Blue	Tape	74 / 47	-65°F - 300°F (-54°C - 149°C)	Fixture 30 min. — Full Cure 24 hrs.	•	CFIA
262™	487231 492141	6 ml tube 36 ml bottle	High strength locking up to ¾" (19 mm) bolts	Red	1,800/5,000 Thixotropic	189 / 275	-65°F - 300°F (-54°C - 149°C)	Fixture 5 min. — Full Cure 24 hrs.	•	Mil-Spec (S-46163A) Type II, Grade O, Agriculture Canada approved
263™	2203451 2205310	6 ml tube 36 ml bottle	Up to 1" (25 mm) bolts with light oil contamination	Red	400/600	290 / 290	-65°F - 360°F (-54°C - 182°C)	Fixture 10 min. — Full Cure 24 hrs.	Yes	CFIA
271™	487232 492142	6 ml tube 36 ml bottle	High strength for fasteners up to 1" (25 mm) diameter	Red	500	250 / 275	-65°F - 300°F (-54°C - 149°C)	Fixture 10 min. — Full Cure 24 hrs.	•	Mil-Spec (S-46163A) Type I, Grade K, UL classified, CFIA
272™	492143	6 ml tube 36 ml bottle	High temperature applications	Red	9,500	200 / 220	-65°F - 450°F (-54°C - 232°C)	Fixture 1 hr. — Full Cure 24 hrs.	•	CFIA
277™	555353	36 ml bottle	High strength for large bolts	Red	7,000	275 / 275	-65°F - 300°F (-54°C - 149°C)	Fixture 60 min. — Full Cure 24 hrs.	•	Mil-Spec (S-46163A) Type I, Grade L
290™	487234 492144	6 ml tube 36 ml bottle	Wicking grade for pre-assembled parts	Green	12	90 / 260	-65°F - 300°F (-54°C - 149°C)	Fixture 20 min. — Full Cure 24 hrs.	•	Mil-Spec (S-46163A) Type III, Grade R, CFIA
Blue Stick Threadlocker	504466 506166	19 g stick 9 g stick	Removable grade up to ¼" to ¾" (6 mm to 19 mm) bolts	Blue	Semisolid	226 / 36	-65°F - 300°F (-54°C - 149°C)	Fixture 5 min. — Full Cure 24 hrs.	Yes	CFIA
Red Stick Threadlocker	511535 511537	19 g stick 9 g stick	High strength locking up to ¾" (19 mm) bolts	Red	Semisolid	311 / 83	-65°F - 300°F (-54°C - 149°C)	Fixture 5 min. — Full Cure 24 hrs.	Yes	CFIA

THREAD SEALANTS

LOCTITE® thread sealants seal and secure metal pipes and fittings, filling the space between threaded metal parts. Thread sealants harden to prevent leakage caused by vibration loosening, tape shredding, solvent evaporation, damaged threads and temperature cycling. Designed for low and high pressure applications, thread sealants seal instantly for on-line low pressure testing. When fully cured, they seal to the burst strength of most piping systems.



LOCTITE® THREAD SEALANT STICK

HIGH PERFORMANCE

The LOCTITE® Thread Sealant Stick is a single-component, semisolid anaerobic pipe sealant compound. The self-feeding applicator stick facilitates application of the material where a conventional liquid or paste would be difficult to use. LOCTITE® Thread Sealant Stick cures rapidly to provide immediate low pressure sealing. The controlled lubricity prevents galling and protects mated threaded areas from rust and corrosion, and eases disassembly. Recommended for sealing metal tapered pipe threads and fittings in automotive applications.

Typical Applications: Stainless steel fittings, oil and coolant lines, fuel fittings, rear axle fill plug, intake manifold switches, head bolts into through holes, oil psi-sending units and sensors.

Item	Container Size	Pack
504467	19 g stick	6



LOCTITE® THREAD SEALANT 565™

HIGH PERFORMANCE

This controlled strength sealant is formulated specifically for metal, tapered pipe thread fittings. LOCTITE® 565™ Thread Sealant replaces most tapes and pipe dopes. Cures rapidly to withstand 10,000 psi. Perfect as a replacement for pre-coated parts. Prevents galling and protects mated threaded areas from rust and corrosion.



Typical Applications: Stainless steel fittings, head bolts into through holes, oil psi-sending units/sensors, oil and coolant lines, intake manifold switches, rear axle fill plug, fuel fittings.

Item	Container Size	Pack
483629	50 ml tube	6



LOCTITE® THREAD SEALANT 545™

PNEUMATIC/HYDRAULIC

LOCTITE® Thread Sealant 545™ is designed for locking and sealing high-pressure pneumatic and hydraulic systems. The pneumatic/ hydraulic sealant contains no fillers or particles that could contaminate system fluids, foul valves, or clog fine filters and screens. Reliably cures on “as received” fasteners. Controlled locking strength allows easy disassembly.



Typical Applications: Hydraulic line fittings, brake fittings, transmission fluid fittings, PTO fittings.

Item	Container Size	Pack
492145	36 ml bottle	6



LOCTITE® THREAD SEALANT 592™

HIGH TEMPERATURE

LOCTITE® 592™ Thread Sealant locks and seals threaded fittings. Resists leakage, vibration loosening, moisture, hydraulic fluids, and diesel fuels. Lubricates threads for easy assembly and disassembly. Won't shred or wear like tape. Parts may be repositioned up to 24 hours after application. Works up to 400°F.



Typical Applications: Head bolts into through holes, oil psi-sending units and sensors, oil and coolant lines, fuel fittings, rear axle fill plug, brake and power steering fittings.

Item	Container Size	Pack
483631	6 ml tube	12
483630	50 ml tube	6

THREAD SEALANTS



LOCTITE® THREAD SEALANT WITH PTFE

FITTING SEALANT

This economical, general-purpose fitting sealant outperforms tapes and pipe dopes. Seals and resists pressure in air, oil, and diesel fuel. Remains pliable at high and low temperatures. Temperature range: -65°F to 300°F (-54°C to 149°C); resists common shop fluids.

Typical Applications: Air conditioning fittings, temperature sending fittings, hydraulic fittings.

Item	Container Size	Pack
1533652	16 oz. brushtop bottle	12



LOCTITE® HEAD BOLT & WATER JACKET SEALANT

LOCTITE® Head Bolt & Water Jacket Sealant is a single-component anaerobic hybrid that lubricates fasteners during assembly, as well as seals the gaps between the threads. It eliminates corrosion, which can cause difficulties if future disassembly is required. The Head Bolt & Water Jacket Sealant locks the bolts in order to prevent premature loosening and, should the assembly need to be taken apart in the future, acts as a lubricant to ease the removal of fasteners that are through holes into water jackets.

Typical Applications: Head bolts, water pump bolts, thermostat housings, intake manifold bolts, temperature sensors.

Item	Container Size	Pack
1158514	50 ml tube	6

PROPERTIES CHART: THREAD SEALANTS

LOCTITE® PRODUCT	Part Number	Container	Typical Use	Color	Viscosity (cP)	Seal to Operating Pressure	Specific Gravity	Agency Approvals
Thread Sealant Stick	504467	19 g stick	General purpose	White	Semisolid paste	Seals operating pressures to 10,000 psi	•	UL Classified for U.S., ULC Classified for Canada, CSA International, CFIA, NSF/ANSI 61
545™	492145	36 ml bottle	Pneumatic/hydraulic sealant, contains no fillers	Purple	14,000	Seals operating pressures to 10,000 psi	1.02	Agriculture Canada approved ABS
565™	483629	50 ml tube	Controlled strength	White	300,000	Seals operating pressures to 10,000 psi	1.10	CSA 3319-81, 3319-01 UL MH8007 (N) ULC-Canada approved Agriculture Canada approved
592™	483631 483630	6 ml tube 50 ml tube	High temperature, medium strength	White	350,000	Seals operating pressures to 10,000 psi	1.21	UL MH8007 (N) ULC-Canada approved Agriculture Canada approved
Head Bolt & Water Jacket Sealant	1158514	50 ml tube	General purpose fastener during assembly	Black	Paste	Seals operating pressures to 10,000 psi	N/A	N/A
Thread Sealant with PTFE	1533652	16 oz. brushtop bottle	General purpose, added lubricity	White	Paste	10,000 to 50,000 psi	N/A	N/A

RETAINING COMPOUNDS

Use LOCTITE® Retaining Compounds to bond non-threaded, cylindrical metal assemblies. Fill the inner voids in close-fitting press fits, lock keyways and secure splines. Prevent wear and secure new parts, or restore fit to worn parts. Seal joints to stop leakage and prevent fretting and corrosion. Mount bearings and bushings, and make press fits and interference fits even stronger.

Formulated in a selection of viscosity, gap-filling ability, flexibility and strength characteristics, LOCTITE® Retaining Compounds can be used on all of your tough retaining applications.



LOCTITE® PRESS FIT REPAIR 660™ FOR WORN PARTS

LOCTITE® Press Fit Repair 660™ is a creamy, non-running adhesive used to repair fit between parts. Also used to repair large gaps to 0.020" (.508 mm) in diameter and severely worn parts. Very rapid cure.



Typical Applications: Refitting worn shafts, housings, coupling and form-in-place shims, repairing worn keyways, loose set screws and other severely worn parts.

Item	Container Size	Pack
555337	50 ml tube	6



LOCTITE® BEARING MOUNT 620™ HIGH TEMPERATURE

A high temperature (450°F/232°C), high viscosity liquid retaining compound. Provides a shear strength of over 3,800 psi on steel. Locks and secures metal cylindrical assemblies up to 0.015" (0.381 mm) diameter clearance. Prevents metal fretting and corrosion. Seals against leakage.



Typical Applications: Axle bearings, water and power steering pump pulleys.

Item	Container Size	Pack
555338	36 ml bottle	6



LOCTITE® SLEEVE RETAINER 640™ HIGH STRENGTH

High temperature anaerobic adhesive that secures slip and press fit assemblies. Adds up to 3,000 psi holding power. Restores fit to worn or out-of-tolerance assemblies. Prevents surface corrosion. Works to 400°F (204°C).



Typical Applications: Cylinder sleeves, valve guides, valve seats, bearings and bushings, Woodruff keys, liner assemblies.

Item	Container Size	Pack
487235	6 ml tube	12
492147	36 ml bottle	6



LOCTITE® BEARING MOUNT 680™ RELAXED FITS

High strength, medium viscosity anaerobic adhesive for slip fit assemblies. Fixes in 10 minutes at room temperature.



Typical Applications: Replaces set screws, clamp rings, snap rings, wheel bearings, idler shaft, fit bearings.

Item	Container Size	Pack
2301375	36 ml bottle	6

RETAINING COMPOUNDS



LOCTITE® BEARING MOUNT STICK HIGH TEMPERATURE

A revolutionary method to bond non-threaded, cylindrical metal assemblies, this unique wax-like stick works just like LOCTITE® Retaining Compound liquids to secure parts, seal joints and prevent corrosion. Replaces clamp rings, set screws and snap rings.

Typical Applications: Bushings, bearings, oil seals, ring gear bolts, differential lock pins, axle bearings, water and power steering pump pulleys.

Item	Container Size	Pack
640482	9 g stick	10



PROPERTIES CHART: RETAINING COMPOUNDS

LOCTITE® PRODUCT	Part Number	Container	Typical Use	Color	Maximum Gap Fill (Diametrical)	Viscosity (cP)	Shear Strength Steel/Steel (psi)*	Temperature Range	Cure Speed, Steel @ 25°C	Specific Gravity	Agency Approvals
620™	555338	36 ml bottle	High temperature and high strength	Green	0.015" (0.381 mm)	8,500	3,800	-65°F – 450°F (-54°C – 232°C)	Fixture 30 min. — Full Cure 24 hrs.	1.16	Agriculture Canada approved ABS
640™	487235 492147	6 ml tube 36 ml bottle	For high temperature applications	Green	0.007" (0.1778 mm)	600	3,000	-65°F – 400°F (-54°C – 204°C)	Fixture 1 hour — Full Cure 24 hrs.	1.12	Mil-Spec (R-46082B) Type II
660™	555337	50 ml tube	For repair of worn machinery parts	Silver	0.020" (0.508 mm)	250,000/ 1,500,000 Thixotropic	3,335	-65°F – 300°F (-54°C – 149°C)	Fixture 20 min. — Full Cure 24 hrs.	1.13	Agriculture Canada approved
680™	2301375	36 ml bottle	High strength for slip fitted parts	Green	0.015" (0.381 mm)	1,250	2,800 (minimum)	-65°F – 300°F (-54°C – 149°C)	Fixture 10 min. — Full Cure 24 hrs.	1.11	ABS
Bearing Mount Stick	640482	9 g stick	General purpose, high temperature	Green	0.005" (0.127 mm)	Semisolid	3,800	-65°F – 400°F (-54°C – 204°C)	Fixture 30 min. — Full Cure 24 hrs.	1.1228	•

* Varies with substrates.

ADHESIVES

As an adhesive innovator, Henkel offers a range of quality liquids, pastes, aerosols, putties and gels, each specifically designed to meet any number of automotive applications. From bonding auto trim, to sealing weatherstripping, to repairing broken grilles, there's a LOCTITE® adhesive or sealant for all of your repair needs.



LOCTITE® UNIVERSAL BONDER 4070™ ADHESIVE

With a powerful combination of speed and strength, LOCTITE® Universal Bonder 4070™ solves virtually any repair challenge when time is limited. Able to rapidly bond a variety of vehicle components with high strength performance, LOCTITE® Universal Bonder 4070™ makes versatile repairs that are fast and easy. It is an essential repair adhesive.

Typical Applications: Interior molding clips, consoles, dash components, molded bumpers, body, trim repair.

Item	Container Size	Pack
2264448	11 g cartridge	10

LOCTITE® CA MIX NOZZLE, (5) PACK

Extra mix nozzles. One package includes 5 mix nozzles.

Item	Container Size	Pack
1434516	5 nozzles	1



LOCTITE® WINDSHIELD REPAIR KIT

ONE-COMPONENT SYSTEM

A one-component windshield repair system designed to be used by the car owner. Requires no mixing, no heat. Safe and easy to use. Has the same index of refraction as the original glass to make the repair virtually undetectable.

Typical Applications: “Bullseyes” in windshields or other laminated glass windows.

Item	Container Size	Pack
504465	0.17 fl. oz. syringe	12

ADHESIVES



LOCTITE® REARVIEW MIRROR ADHESIVE

PERMANENT

Approved and used by GM, Ford and Chrysler. Permanently remounts mirrors to windshields. Achieves handling strength in seconds; mirror-mounting strength in 15 minutes. Available in single and multi-application size packaging.



Typical Applications: Mounting rearview mirrors to windshields.

Item	Container Size	Pack
487865	0.3 cc kit	12
236971	6 ml kit	12
228190	24 ml kit	



LOCTITE® EPOXY QUICK SET™ ADHESIVE

Fast curing, non-shrinking, colorless epoxy in convenient, two-part dispensing syringe. Bonds most rigid materials. Resists most solvents. Versatile and shock resistant.

Typical Applications: Auto trim, ornaments, tools, emblems, knobs.

Item	Container Size	Pack
1395391	0.85 fl. oz. syringe	8



LOCTITE® REAR WINDOW DEFOGGER TAB ADHESIVE

TAB ADHESIVE

Quickly and easily bonds defogger tab to grid on rear window. Provides a low-cost, high-quality repair for damaged rear window defogger tabs. Complete kit for a quick repair.

Typical Applications: Rear window defogger tabs.

Item	Container Size	Pack
194080	0.03/0.02 fl. oz.	6



LOCTITE® QUICK GEL® SUPER GLUE

INSTANT ADHESIVE

This gel formula super glue was designed for fast, heavy-duty repairs to vertical surfaces, where regular adhesive runs. Works on porous and non-porous materials.



Typical Applications: Metal, most plastics, laminated plastics, vinyl, rubber, ceramics, paper, wood, textiles, leather, synthetic leather, cork, and chipboard.

Item	Container Size	Pack
483624	2 g tube	12



LOCTITE® EPOXY PLASTIC BONDER ADHESIVE

ADHESIVE

Acrylic formula, specially formulated to bond and repair plastic surfaces. When mixed in equal volumes, the components react to produce a tough, rigid, high strength bond in 20 to 25 minutes. Can be sanded and drilled.

Typical Applications: Bonding substrates such as: PVC, polycarbonate, acrylic, ABS, FRP, nylon, Mylar®, Delrin®, phenolic, aluminum and stainless steel.

Item	Container Size	Pack
1363118	0.85 fl. oz. tube	8

ADHESIVES



LOCTITE® SUPER GLUE PROFESSIONAL

INSTANT ADHESIVE

Proven superior performance over ordinary super glues. It dries clear and sets without clamping. It's resistant to moisture, most chemicals and freezing temperatures.

Typical Applications: Ideal for heavy-duty projects and repairs. Repairing figurines, costume jewelry, cameras, toys, metal car parts, wiper blades, rubber seals and O-rings.

Item	Container Size	Pack
1365882	20 g bottle	4



LOCTITE® SUPER GLUE LONGNECK BOTTLE

INSTANT ADHESIVE

Features a precision tip that allows controlled application without dripping. The long nozzle is ideal for gluing hard-to-reach surfaces.

Typical Applications: Bonds ceramic, rubber, paper, metal, china, wood and most plastics

Item	Container Size	Pack
230992	5 g bottle	6



LOCTITE® SUPER GLUE LIQUID

INSTANT ADHESIVE

Super strong, super fast adhesive bonds materials in seconds, including rubber, metal, plastic, glass and vinyl. Makes repairs to almost all non-porous surfaces.

Typical Applications: Metal, laminated plastics, rubber, ceramics, china.

Item	Container Size	Pack
1399967	2 g tube	12



LOCTITE® SUPER GLUE ULTRA LIQUID CONTROL

INSTANT ADHESIVE

The liquid formula works well on a variety of porous and non-porous surfaces. Comes in a patented side-squeeze design for maximum control. It dries clear and sets without clamping. Resistant to moisture, most chemicals and freezing temperatures.

Typical Applications: Repairing figurines, costume jewelry, cameras, toys, metal car parts, wiper blades, rubber seals and O-rings.

Item	Container Size	Pack
1647358	4 g applicator	6



LOCTITE® SUPER GLUE ULTRA GEL CONTROL

INSTANT ADHESIVE

Specially formulated, rubber-toughened instant adhesive that resists impact, shock, vibration and temperature extremes. Ideal for bonds subject to daily use and harsh conditions. Dries clear and is resistant to moisture and freezing temperatures.

Typical Applications: Bonding leather, cork, paper, cardboard, wood, chipboard, fabric, metal, ceramic, rubber, hard plastics, polycarbonate, polystyrene and PVC.

Item	Container Size	Pack
1363589	4 g applicator	6

ADHESIVES



LOCTITE® RTV BLACK SILICONE ADHESIVE/SEALANT

General-purpose, black RTV indoor/outdoor sealant. Seals, bonds, repairs, mends and secures glass, metal, plastics, fabric, vinyl, weatherstripping and vinyl tops. Protects and repairs electrical wiring. May be applied to horizontal or vertical surfaces. Waterproof and flexible. Temperature range: -80°F to 450°F (-62°C to 232°C); resists oil, water, weather, vibration, grease.

Typical Applications: Windshields, door frames, electrical connections, seams and roofs, vinyl tops, weatherstripping.

Item	Container Size	Pack
491979	80 ml tube	12
2093365	190 ml power can aerosol	6
495315	300 ml cartridge	10



LOCTITE® SUPER GLUE GEL INSTANT ADHESIVE

With the same superior performance as the liquid version, the no-run gel formula stays put for no-mess and precise application, even on vertical surfaces. The gel formula works on porous and non-porous materials.

Typical Applications: Metal, most plastics, rubber, vinyl, paper, wood, textiles, ceramics, china and cork.

Item	Container Size	Pack
636095	4 g applicator	6



LOCTITE® RTV CLEAR SILICONE ADHESIVE/SEALANT

General-purpose, clear RTV indoor/outdoor sealant. Seals, bonds, repairs, mends and secures glass, metal, plastics, fabric, vinyl, weatherstripping, and vinyl tops. Protects and repairs electrical wiring. May be applied to horizontal or vertical surfaces. Waterproof and flexible. Temperature range: -80°F to 450°F (-62°C to 232°C); resists oil, water, weather, vibration, grease.

Typical Applications: Windshields, door frames, electrical connections, vinyl tops, seams and roofs.

Item	Container Size	Pack
491981	80 ml tube	12
2093366	190 ml power can aerosol	6
495076	300 ml cartridge	10



LOCTITE® EPOXY MIXER IN CUPS FAST CURE

Convenient pre-measured epoxy mixer cups. No mess, no guess, no waste. Ideal for bonding glass, hard plastics, rubber, and metal. Bonds in 5 to 15 minutes. Grey adhesive has excellent chemical resistance. Fills porosities and can be used to build up worn parts.

Typical Applications: Loose trim, broken grilles, loose door glass channels, casting cracks and holes.

Item	Container Size	Pack
494151	10-0.12 oz. cups	10



LOCTITE® VINYL, FABRIC & PLASTIC REPAIR ADHESIVE

LOCTITE Vinyl, Fabric & Plastic Flexible Adhesive is a clear liquid adhesive formulated for repairing and mending flexible plastics such as vinyl seats, cushions, tarps and outdoor gear.

Item	Container Size	Pack
1360694	1 oz	6

ADHESIVES



LOCTITE® LOCWELD™ BONDING COMPOUND COLD WELD

A 15-minute, two-part adhesive and filler system that eliminates the need for welding or brazing. Once cured, it can be drilled, sanded, painted or filed. Resists most automotive, shop and cleaning fluids. Withstands temperatures to 300°F intermittent. Over 3,000 psi shear strength on steel.

Typical Applications: Aluminum, steel, brass, bronze, castings and stampings.

Item	Container Size	Pack
495540	2 pack – 1 oz. tubes	12



LOCTITE® 3092™ ADHESIVE KIT

Ultra-fast gel adhesive that can bond gaps up to 2 mm in depth. Excellent for general repairs. Virtually eliminates blooming or frosting. Includes three mix nozzles.

Typical Applications: Interior molding clips, consoles, dash components, molded bumpers, body, trim repair.

Item	Container Size	Pack
1807961	10 g syringe	12

LOCTITE® CA MIX NOZZLE, (5) PACK

Extra mix nozzles. One package includes 5 mix nozzles.

Item	Container Size	Pack
1434516	5 nozzles	1



LOCTITE® SUPER GLUE INSTANT ADHESIVE

Super strong, super fast adhesive bonds materials in seconds, including rubber, metal, plastic, glass and vinyl. Makes repairs to almost all non-porous surfaces.

Typical Applications: Metal, laminated plastics, rubber, ceramics, vinyl.

Item	Container Size	Pack
487236	2 g tube	12



LOCTITE® STIK 'N SEAL® EXTREME CONDITIONS CONTACT ADHESIVE

Contains the revolutionary Flextec formulation, which bonds more surfaces faster than ordinary household adhesives. It is a versatile, heat-resistant adhesive that bonds, seals and repairs most materials.

Typical Applications: Ideal for bonds subject to harsh or extreme conditions or for situations where constant flexing is a problem. Indoor/outdoor use, excellent adhesion, high initial grab, cures quickly.

Item	Container Size	Pack
1360784	0.58 fl. oz. tube	6



ADHESIVES



LOCTITE® OIL & GAS RESISTANT ADHESIVE SEALANT

A premium, neoprene adhesive and sealant that is oil, gas and anti-freeze resistant. Dries clear in 30 minutes with temperature resistance up to 140°F.

Typical Applications: Bonds rubber, plastic, weatherstrip, carpeting and metal to porous surfaces.

Item	Container Size	Pack
1252795	30 ml tube	6



LOCTITE® SPRAY ADHESIVE PROFESSIONAL PERFORMANCE

LOCTITE® Spray Adhesive Professional Performance is a premium quality formulation that creates high strength and high-temperature-resistant permanent bonds. It dries clear and is non-yellowing. For light and demanding applications. Can be used indoors and outdoors.

Typical Applications: Decorative laminate/trim work, marine applications, upholstery work, carpet, van/motor home conversions, kick plates and signage. Ideal where support is not possible.

Item	Container Size	Pack
2267077	13.5 oz. aerosol can	6



LOCTITE® PL MARINE FAST CURE ADHESIVE SEALANT

A fast setting, moisture cure poly etheradhesive sealant which delivers strong bonds while forming a watertight, flexible seal above or below the waterline once cured. Once cured, it withstands both saltwater and freshwater environments.

Typical Applications: hrough-hull fastening, deck fittings, deck to hull joints, portlights, moldings, struts and planking, and stem joints.

Item	Container Size	Pack
2020627	3 fl oz tube	?
2016891	10 fl oz. cartridge	?



LOCTITE® BLACK WEATHERSTRIP ADHESIVE FAST DRYING

A professional, black weatherstrip adhesive that blends with automotive weatherstripping for less cleanup. Withstands temperature extremes. Resistant to gasoline, kerosene, antifreeze, and most solvents. Permanently bonds automotive weatherstripping. Bonds automotive gaskets. A superior adhesive for bonding a variety of common materials.

Typical Applications: Cut gaskets, auto or van carpeting, door and trunk moldings, vinyl tops, fabric-backed vinyl upholstery, headliners.

Item	Container Size	Pack
495541	5 fl. oz. tube	12



LOCTITE® YELLOW WEATHERSTRIP ADHESIVE FAST DRYING

A fast drying, high strength, waterproof adhesive that closely color-matches original equipment materials. Professional strength bonds all types of weatherstripping materials and sunroof moldings. Resistant to oils, water and grease.

Typical Applications: Auto or van carpeting, all types of weatherstripping, door and trunk moldings.

Item	Container Size	Pack
782111	5 fl. oz. tube	12



LOCTITE® MARINE EPOXY

A two-part system consisting of an epoxy resin and a hardener. It can be applied and cured underwater. Ideal for repairing pipes. It cures to an off-white finish and can be easily sanded or machined. It does not shrink and is resistant to water and most common solvents.

Typical Applications: Bonding metal, concrete, glass, fiberglass, ceramic, wood and certain rigid plastics. Use for surfaces exposed to water immersion. Ideal for PVC, copper, aluminum, brass and galvanized pipes.

Item	Container Size	Pack
1919424	0.85 fl. oz. syringe	?

GASKETING

Any gasket shape, any time.

Henkel's innovative LOCTITE® gasketing products offer precise, reliable sealing. These gasketing materials include products with excellent fluid resistance and formulations for high operating temperatures, high torque retention and sensor-safe characteristics. A leader in form-in-place gasket makers, gasket dressings and general-purpose sealants, Henkel offers a choice of LOCTITE anaerobic, RTV silicone or solvent-based products to meet a broad range of complex automotive gasketing and sealing needs.



GASKETING

EASY DISPENSE POWER CAN AEROSOLS

- More accurate dispensing of constant, steady silicone beads
- Ergonomic and easy-to-use fingertip trigger
- Silicone product and dispense system in one, eliminating the need for a caulking gun
- Attached nozzles – no more searching for displaced nozzles
- Nonflammable products
- Propellants used are V.O.C.-free

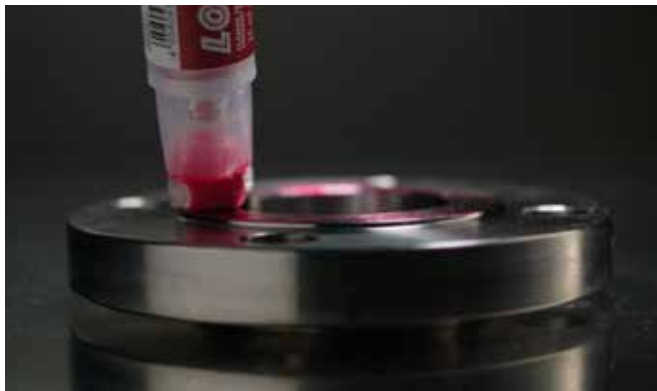

THE FASTEST, EASIEST WAY TO APPLY LIQUID GASKETS

The new LOCTITE® 518 pen combines the leak-fighting properties of LOCTITE® Gasket Maker 518™ with a roll-on applicator that makes applying liquid gasket easier than ever with less waste and less mess.

- Easy to apply
- Reduces inventory – 1 package for any size or shape gasket needed
- Total surface coverage
- Reliable, long-lasting seal
- No gaps, breaks or distortion
- High performance on inactive metals
- High blow-out resistance
- Ease of disassembly

GASKETING



LOCTITE® 587™ RTV BLUE SILICONE GASKET MAKER

HIGH PERFORMANCE

Forms tough, flexible gaskets directly on the flange. Sensor-safe, low odor, noncorrosive. Excellent oil resistance and joint movement values. Eight times more flexible than cork/composite gaskets; three times more oil-resistant than conventional silicones. Temperature range: -75°F to 500°F (-59°C to 260°C) intermittent; resists auto and shop fluids.

Typical Applications: Valve covers, oil pans, timing covers, transmission pans, differential covers.

Item	Container Size	Pack
491983	80 ml tube	12
2093364	190 power can aerosol	6
495072	300 ml cartridge	10



LOCTITE® 5699™ RTV GREY SILICONE GASKET MAKER

HIGH PERFORMANCE

Designed for high torque applications. Exceeds manufacturers' performance requirements. Remains flexible and withstands high vibration. Low odor. Noncorrosive. Outstanding oil resistance. Temperature range: -75°F to 625°F (-59°C to 329°F) intermittent; resists auto and shop fluids.

Typical Applications: Valve covers, oil pans, intake manifold end seals, timing covers, water pumps, thermostat housings.

Item	Container Size	Pack
491982	80 ml tube	12
2093363	190 ml power can aerosol	6



LOCTITE® 598™ RTV BLACK SILICONE GASKET MAKER

HIGH PERFORMANCE

For dealership warranty requirements, ensures extended drivetrain warranty compliance. Fast-curing formula.

Sensor-safe, low odor, noncorrosive. Meets performance specs of OE silicone gaskets. Retains high flexibility, oil resistance properties. Temperature range: -75°F to 625°F (-59°C to 329°C) intermittent; resists auto and shop fluids and vibration.

Typical Applications: Valve covers, oil pans, intake manifold end seals, timing covers, transmission pans.

Item	Container Size	Pack
491985	80 ml tube	12
2093362	190 ml power can aerosol	6
495075	8.75 oz. pressurized can	6
495074	300 ml cartridge	10



LOCTITE® 5920™ RTV COPPER SILICONE GASKET MAKER

HIGH PERFORMANCE

Premium silicone for 4-cylinder, turbocharged or high-performance engines. Sensor-safe, low odor, noncorrosive, low volatility, non-conductive. Superior adhesion and oil resistance. Temperature range: -75°F to 700°F (-59°C to 371°C) intermittent; resists auto and shop fluids and vibration.

Typical Applications: Valve covers, oil pans, timing covers, water pumps and thermostat housings.

Item	Container Size	Pack
491984	80 ml tube	12



GASKETING



LOCTITE® RTV BLUE SILICONE GASKET MAKER

SENSOR SAFE

Replaces almost any cut gasket. Makes reliable “formed-in-place” gaskets that resist cracking, shrinking and migrating. Coats pre-cut gaskets to increase reliability. Temperature range: -65°F to 500°F (-54°C to 260°C) intermittent; resists auto and shop fluids. Will not foul oxygen sensors when fully cured.

Typical Applications: Valve covers, oil pans, timing covers, water pumps, thermostat housings, transmission pans.

Item	Container Size	Pack
491980	80 ml tube	12
2093361	190 ml power can aerosol	6
495318	300 ml cartridge	10



LOCTITE® RTV RED SILICONE GASKET MAKER

SENSOR SAFE/HI TEMP

Formulated for oxygen sensor-equipped engines. Temperature range: -75°F to 600°F (-59°C to 316°C) intermittent; resists auto and shop fluids, aging and thermal cycling without shrinking, cracking or hardening. Will not foul oxygen sensors when fully cured.

Typical Applications: Valve covers, oil pans, timing covers, water pumps, thermostat housings, transmission pans.

Item	Container Size	Pack
492001	80 ml tube	12
2093360	190 ml power can aerosol	6
495538	7.25 oz. pressurized can	12
495536	300 ml cartridge	10



LOCTITE® READY GASKET GASKET MAKER

Makes high performance leakproof gaskets in one minute. This elastomeric rubber gasket technology is blowout resistant, sensor safe and outperforms pre-cut gaskets. Equipment can be returned to service immediately. Specified on production lines by GM, Ford and Chrysler. Temperature range: -75°F to 450°F (-60°C to 232°C) continuous, 500°F (260°C) intermittent; resists ATF, coolant, oil and other shop fluids. Protects against leaks caused by vibration and thermal expansion.



Typical Applications: Automotive and marine gaskets, valve covers, gearbox covers, pumps, compressors, oil pans, thermostat housings, water pumps.

Item	Container Size	Pack
494150	5 oz. cartridge	6
743914	190 ml power can aerosol	6
2207527	300 ml cartridge	10



GASKETING



LOCTITE® 515™ GASKET MAKER ANAEROBIC

Flexible gasketing material for use on rigid machined flanges with less than 0.015" (0.381 mm) gap. OEM approved – use where OEs specify 515™ or “anaerobic” gasket (cures in absence of air). Eliminates preformed, pre-cut, paper, rubber and cork gaskets. Flexes with flanges that move in service. See properties chart on page 29.



Typical Applications: Water pumps, thermostat housings, transmission pans, transmission case covers, transaxle casings, O-ring replacement.

Item	Container Size	Pack
555352	50 ml tube	6



LOCTITE® HI-TACK STICK GASKET DRESSING

Formulated to work like LOCTITE® Hi-Tack Gasket Sealant liquid, but this wax-like stick is less messy, has a low odor, and is solvent-free. LOCTITE® Hi-Tack Stick sets quickly to a very tacky film, and seals and holds the heaviest gaskets in place. Resists gasoline, oil, and common shop fluids. See properties chart on page 29.

Typical Applications: Valve covers, fuel pumps, carburetors, manifold gaskets.

Item	Container Size	Pack
640807	19 g stick	6



LOCTITE® GASKET MAKER 518™ ANAEROBIC

Noncorrosive anaerobic designed primarily for use on aluminum, iron and steel flanged mating surfaces. Ideal for on-the-spot and emergency repairs, or when a conventional gasket is out of stock. Fills gaps up to 0.050" (1.27 mm) and forms a flexible, solvent-resistant seal that will not tear or decay. Parts disassemble easily, even after extended service, and old gasket material can be removed with a putty knife. See properties chart on page 29.



Typical Applications: Water pumps, thermostat housings, transmission pans, transmission case covers, transaxle casings, O-ring replacement.

Item	Container Size	Pack
2203452	6 ml tube	12
2096059	50 ml tube	6
2096063	300 ml cartridge	10
2392164	25 ml application pen	12



LOCTITE® HI-TACK GASKET SEALANT GASKET DRESSING

Fast-drying sealant dries to a highly tacky, non-brittle film that holds gaskets in place during assembly. Temperature range: -65°F to 500°F (-54°C to 260°C); resists gasoline, oil, antifreeze, axle lube.

Typical Applications: Valve covers, fuel pumps, carburetors, manifold gaskets.

Item	Container Size	Pack
497091	9 oz. aerosol can	12
153776	16 oz. brushtop can	12

GASKETING



LOCTITE® GASKET SEALANT 2 NON-HARDENING

Reliable, paste-like gasket sealant/dressing/coating. Sets more slowly to a pliable film. Best suited for non-rigid, vibrating assemblies. Allows for easy disassembly if required. Temperature range: -65°F to 400°F (-54°C to 204°C); resists common shop fluids and fuels.



Typical Applications: Valve cover gaskets, oil pan gaskets.

Item	Container Size	Pack
495572	3 oz. tube	12



LOCTITE® COPPER GASKET ADHESIVE

HI-TEMP ADHESIVE SEALANT

Fast-drying, metallic copper sealant helps dissipate heat, prevents gasket burnout and improves heat transfer. Seals instantly. Fills hot spots and surface imperfections. Temperature range: -50°F to 500°F (-46°C to 260°C); resists all types of automotive fluids, especially gasoline.

Typical Applications: Cylinder head gaskets, carburetor gaskets, exhaust manifold gaskets and other high temperature applications.

Item	Container Size	Pack
502911	9 oz. aerosol can	12



LOCTITE® AVIATION GASKET SEALANT

GASKET DRESSING

Slow-drying, non-hardening brushtop sealant approved for use in aviation as well as automotive applications. Temperature range: -65°F to 400°F (-54°C to 204°C); resists gasoline, oil and grease.



Typical Applications: Close-fitting machined surfaces, sealing hoses, solid gaskets.

Item	Container Size	Pack
1525607	16 oz. brushtop bottle	12

GASKETING

GASKETING SELECTOR CHARTS

GENERAL COMPARISON	GASKET TYPE		
	Conventional Gasket Dressings	Formed-in-Place Anaerobics	Formed-in-Place Silicones
BENEFITS	Versatile, immediate green strength (sticky)	Improved structural strength, long open time, high pressure seal	High gap filling, resistant to dynamic fatigue, on-line pressure testing
LIMITATIONS	Non-curing, limited gap fill, % shrinkage	Limited fill	Short open time
PROCESS CONSIDERATIONS	GASKET TYPE		
	Conventional Gasket Dressings	Formed-in-Place Anaerobics	Formed-in-Place Silicones
NUMBER OF COMPONENTS	1	1	1
CURE METHOD	Not Applicable	Anaerobic	RTV
CURE TEMPERATURE	Room Temperature	Room Temperature	Room Temperature
CURE SPEED			
INITIAL CURE	Immediate	15 to 30 min.	15 to 30 min.
FULL CURE	Not Applicable	24 to 72 hours	1 to 7 days
PROCESSING OPTIONS			
MANUAL	Yes	Yes	Yes
AUTOMATED	No	Yes	Yes

PERFORMANCE CONSIDERATIONS	GASKET TYPE		
	Conventional Gasket Dressings	Formed-in-Place Anaerobics	Formed-in-Place Silicones
TEMPERATURE RESISTANCE			
CONTINUOUS OPERATION	-65°F to 400°F (-54°C to 204°C)	-40°F to 300°F (-40°C to 149°C)	-60°F to 400°F (-51°C to 204°C)
MAXIMUM	600°F (316°C)	400°F (204°C)	725°F (385°C)
FLUID RESISTANCE			
OIL	Yes	Yes	Yes
WATER/GLYCOL	Yes	Yes	Yes
FUEL	Limited	Limited	No
TRANSMISSION FLUID	Yes	Yes	Yes
GAP FILL			
IDEAL	0.001" to 0.005"	0.001" to 0.005"	0.001" to 0.125"
MAXIMUM	0.010" (0.254 mm)	0.050" (1.27 mm)	0.240" (6.096 mm)
INSTANT SEAL	High Pressure	Low Pressure	Low Pressure
FLANGE TYPE	Rigid or Flexible	Rigid	Rigid or Flexible
SUITABLE FOR USE WITH:			
METALS	Yes	Yes	Yes
PLASTICS*	Yes	No	Yes

PROPERTIES CHART: GASKETING

LOCTITE® PRODUCT	Part Number	Container	Color	Viscosity (cP)	Temperature Range	Sealing Time	Agency Approvals
515™	555352	50 ml tube	Purple	275,000/950,000 Thixotropic paste	-65° to 300°F (-54°C to 149°C)	15 min.-2 hrs. w/primer 1-12 hrs. w/o primer	UL Classified for U.S.
518™	2203452 2096059 2096063	6 ml tube 50 ml tube 300 ml cartridge	Red	800,000/3,750,000 Thixotropic paste	-65° to 300°F (-54°C to 149°C)	30 min.-4 hrs. w/primer 4-24 hrs. w/o primer	CFIA
Hi-Tack Stick	640807	19 g stick	Purple	Vertical applications, repositionable	-65° to 300°F (-54°C to 149°C)	5 min. to set	•

* Uncured liquid adhesives may cause stress cracking of certain thermoplastics (e.g., polycarbonates, acrylic and polysulfone).

GASKETING

PROPERTIES CHART: GASKETING

LOCTITE® PRODUCT	Part Number	Container	Color	Oil Resistance	Noncorrosive	Temperature Range	Sealing Time	Agency Approvals
Ready Gasket	494150 743914 2207527	5 oz. cartridge 190 ml power can aerosol 300 ml cartridge	Black	Increased oil resistance	Noncorrosive	-75° to 500°F (-59° to 260°C) intermittent	Operating Strength 15 psi - 1 min.	GM 998-5990 Ford WSE-M4G 323-A6 Chrysler GF-44-A
RTV Blue Silicone	491980 2093361 495318	80 ml tube 190 ml power can aerosol 300 ml cartridge	Blue	•	•	-65° to 500°F (-54° to 260°C) intermittent	Tack-free 30 min. — Full Strength 24 hrs.	•
RTV Red Silicone	492001 495538 2093360 495536	80 ml tube 7.25 oz. can 190 ml power can aerosol 300 ml cartridge	Red	•	•	-75° to 600°F (-59° to 316°C) intermittent	Tack-free 30 min. — Full Strength 24 hrs.	CFIA
RTV 598™ Black Silicone	491985 2093362 495075 495074	80 ml tube 190 ml power can aerosol 8.75 oz. can 300 ml cartridge	Black	Excellent oil resistance	Noncorrosive	-75° to 625°F (-59° to 329°C) intermittent	Tack-free 30 min. — Full Strength 24 hrs.	American Bureau of Shipping, CFIA
RTV 587™ Blue Silicone	491983 2093364 495072	80 ml tube 190 ml power can aerosol 300 ml cartridge	Blue	Increased oil resistance	Noncorrosive	-75° to 500°F (-59° to 260°C) intermittent	Tack-free 30 min. — Full Strength 24 hrs.	American Bureau of Shipping, UL Classified for U.S., CFIA
RTV 5920™ Copper Silicone	491984	80 ml tube	Copper	Increased oil resistance	Noncorrosive	-65° to 700°F (-54° to 371°C) intermittent	Tack-free 60 min. — Full Strength 24 hrs.	CFIA
RTV 5699™ Grey Silicone	491982 2093363	80 ml tube 190 ml power can aerosol	Grey	Increased oil resistance	Noncorrosive	-75° to 625°F (-59° to 329°C) intermittent	Tack-free 30 min. — Full Strength 24 hrs.	CFIA
Aviation Gasket Sealant	1525607	16 oz. brushtop bottle	Dark reddish brown	Oil resistant	Noncorrosive	-65° to 400°F (-54° to 204°C)	Full Strength 12 hrs.	•
Gasket Sealant 2	495572	3 oz. tube	Black	Oil resistant	Noncorrosive	-65° to 400°F (-54° to 204°C)	Remains tacky	•
Hi-Tack Gasket Sealant	497091 1537776	9 oz. aerosol 16 oz. brushtop can	Red	Increased oil resistance	Noncorrosive	-65° to 500°F (-54° to 260°C) Aerosol to 600°F	5 min. to set	•
Copper Gasket Adhesive	502911	9 oz. aerosol	Copper	Oil resistant	Noncorrosive	-50° to 500°F (-45° to 260°C)	Remains tacky	•

LUBRICANTS

Reduce wear and tear.

LOCTITE® anti-seize and lubricating compounds are a group of premium quality products developed to protect metal parts from corrosion, galling and seizing. They ease assembly and disassembly of slip-fit, press-fit and threaded joints, and reduce friction and wear at temperatures up to 1800°F. Formulated for severe environments, these products protect against high temperatures, heavy loads, chemicals, pounding and vibration.



LOCTITE® MARINE GRADE ANTI-SEIZE LUBRICANT

Formulated to protect assemblies exposed directly or indirectly to fresh water and salt water, this anti-seize works especially well in high-humidity conditions. It has excellent lubricity, superior water wash-out spray resistance and prevents galvanic corrosion. ASB approved.

Typical Applications: Insert Applications Here

Item	Container Size	Pack
1999556	7 oz. brushtop tube	?
299175	8 oz. brushtop can	?
275026	16 oz. brushtop can	?



LOCTITE® SILICONE LUBRICANT

Lubricates and waterproofs all types of mechanical equipment. Stops friction and squeaks. Coats hinges and channels. Prevents locks, doors and windows from binding. High silicone formula does not attract dust or dirt. Prevents binding, sticking and deterioration.

Typical Applications: Lubricates door locks, trunk lids, brake cables and rubber molding.

Item	Container Size	Pack
503049	13 oz. aerosol can	12

LUBRICANTS



LOCTITE® COPPER ANTI-SEIZE STICK

LOCTITE® Copper Anti-Seize Stick provides a shield against high temperature seizing and galling. Studs, bolts, flanges and other mated parts can be removed easily in typical dry service temperatures up to 1800°F (982°C). The copper anti-seize stick can be used on copper, brass, cast iron, all steel alloys including stainless steel, all plastics and all non-metallic gasketing materials.

Typical Applications: Spark plug threads installed in aluminum, exhaust manifold bolts, engine bolts, thermostat housing bolts, oxygen sensors, battery cable connections.

Item	Container Size	Pack
504468	20 g stick	6



LOCTITE® ANTI-SEIZE LUBRICANT COPPER

A premium quality copper anti-seize and thread lubricant that may be used to prevent seizing, corrosion, and galling where high temperature conditions exist. Temperature range: -30°F to 1800°F (-34°F to 982°C). Provides good electrical conductivity.

Typical Applications: Spark plug threads installed in aluminum, exhaust manifold bolts, engine bolts, oxygen sensors, knock sensors, thermostat housing bolts, fuel filter fittings, and battery cable connections.

Item	Container Size	Pack
500997	3 oz. brushtop bottle	12
555336	8 oz. brushtop bottle	12
500995	1 lb. brushtop bottle	12



LOCTITE® SILVER ANTI-SEIZE STICK

LOCTITE® Silver Anti-Seize Stick is a heavy-duty, temperature-resistant, petroleum-based lubricant compound fortified with graphite and metallic flake. Will not evaporate or harden in extreme cold or heat. Use during assembly to prevent seizing, galling, and corrosion. For use in assemblies up to 1600°F (871°C).

Typical Applications: For easy removal of spark plugs, cylinder head and exhaust head bolts.

Item	Container Size	Pack
504469	20 g stick	6



LOCTITE® ANTI-SEIZE LUBRICANT SILVER

Heavy-duty, temperature-resistant, petroleum-based lubricant compound fortified with graphite and metallic flake. Will not evaporate or harden in extreme cold or heat. Use during assembly to prevent seizing, galling and corrosion. For use in assemblies up to 1600°F (871°C).

Typical Applications: For easy removal of spark plugs, cylinder head and exhaust head bolts.

Item	Container Size	Pack
495556	1 oz. tube	12
501000	8 oz. brushtop bottle	12
623856	12 oz. aerosol can	12
501001	1 lb. brushtop bottle	12



LUBRICANTS



LOCTITE® DISC BRAKE QUIET STICK

ELIMINATES NOISE

Invented and patented by Henkel, this unique wax-like stick is specially formulated to dampen brake pad vibrations and eliminate associated squeaking and noise, without the sticky, smelly mess of traditional solvent and water-based products. LOCTITE® Disc Brake Quiet Stick forms a water-resistant, high temperature film that will absorb vibration and quiet disc braking.

Typical Applications: Apply to disc brake pads at point of contact with caliper.

Item	Container Size	Pack
718808	19 g stick	6

LOCTITE® DISC BRAKE QUIET STICK IS

The only brake squeal product tested that fully meets OEM acceptance criteria.

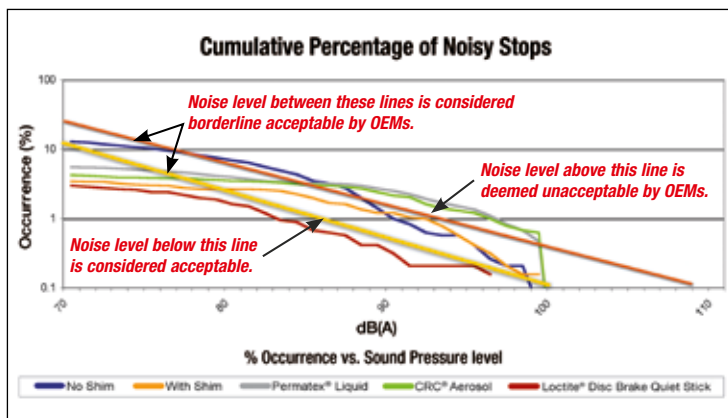

The table below shows the products tested listed in the order of the number of noise events. By studying this table and the adjacent graph, it can be determined that, during these tests, LOCTITE® Disc Brake Quiet Stick was the most effective at reducing brake noise events.

Tested Products	Number of Noise Events	Noise Level
LOCTITE® Disc Brake Quiet Stick	64	Quietest
CRC® Disc Brake Quiet Aerosol	76	I
Permatex® Disk Brake Quiet Liquid	100	I
Baseline with Shim	245	I
Baseline without Shim	245	Noisiest

Test results are based on independent brake noise testing done by Link Testing Laboratories, Inc. using Henkel products and Henkel's competitors' commercially available products. Link Testing Laboratories, Inc. does not endorse or recommend any product. Link Testing Laboratories, Inc. guarantees accuracy and consistency of test results, which are valid for these products under the conditions tested. Any use or reproduction of Link Testing Laboratories, Inc. name, logo, or the name of a Link Testing Laboratories engineer must be approved by Link Testing Laboratories, Inc. before publication. Henkel Corporation has obtained permission from Link Testing Laboratories, Inc. to reproduce the above graph and table.

LUBRICANTS



LOCTITE® DIELECTRIC TUNE-UP GREASE

LUBRICANT

Provides a moisture-proof barrier that lubricates and protects electrical connections and wiring from salt, dirt and corrosion. Extends the life of bulb sockets. Prevents voltage leakage around electrical connections. Required for modern high energy ignition systems.



Typical Applications: Marine and automotive electrical connections, spark plug boots, trailer hitches, battery terminals.

Item	Container Size	Pack
495545	0.33 oz. tube	12
495549	80 ml tube	6



LOCTITE® SYNTHETIC GREASE

HIGH PERFORMANCE

A high performance, NLGI grade 2/Severe duty GC-LB synthetic grease that provides superior protection for parts exposed to a wide range of temperatures and environments. NSF H1 rated.

Typical Applications: Use as a lubricant on all bearings, as a protective anti-rust film, or as a release agent on gaskets and seals. Use as a battery terminal protector.

Item	Container Size	Pack
1906103	10.1 oz. aerosol can	12



LOCTITE® FREEZE & RELEASE™

LOCTITE® Freeze & Release™ instantly freezes seized and rusted parts (bolts, nuts, studs) down to -38°F (-39°C). The exceptional shock-freeze effect causes microscopic cracks in the layer of rust, allowing the lubricant ingredient to wick directly into the rust by capillary action. The assembly can be easily dismantled after allowing only 1-2 minutes penetration time. Released parts remain lubricated and protected from corrosion.

Typical Applications: Seized and corroded assemblies of threaded and cylindrical parts. Any applications where a threadlocker or anti-seize has not been previously used, and rust and corrosion has formed.

Item	Container Size	Pack
2343776	13.52 fl. oz. aerosol	6



LOCTITE® PENETRATING OIL

Heavy-duty penetrant for rusted and frozen assemblies. Works quickly to penetrate and loosen rust, tar, grease, dirt, carbon deposits and corrosion from metal parts. Frees frozen nuts, bolts and fittings in all types of assemblies.

Typical Applications: Lubricates to free any corroded or seized part. Penetrates rust, scale, paint, varnish, carbon or gum.

Item	Container Size	Pack
503054	12 oz. aerosol can	12



SPECIALTY PRODUCTS

If you want to repair, protect, seal, insulate or prevent corrosion, there's a LOCTITE® product for you. Whether you need to make a thread repair, or remove or prevent rust, Henkel has a LOCTITE® brand product that will make your parts and equipment last longer and work better.



LOCTITE® CLOVER® LAPPING & GRINDING COMPOUND 280 GRIT

280 fine grit silicon carbide lapping compound ensures engine valves and valve seats are perfectly mated for maximum power and heat transfer.

Typical Applications: Lapping (abrasive compound) for use in ensuring proper fit of valves to valve seats in gas and diesel engines.

Item	Container Size	Pack
1777012	2 oz.	24

LOCTITE® POWER GRAB CONSTRUCTION ADHESIVE

LOCTITE® Power Grab Industrial Construction Adhesive is a single-component, off-white, heavy duty, high strength, construction grade adhesive for interior and exterior repairs or building projects.

Typical Applications: Bonds to most construction materials, such as metal, ceramic, wood, concrete and most plastics. One surface must be porous.

Item	Container Size	Pack
2137678	300 ml	12



LOCTITE® EXTEND® RUST NEUTRALIZER

Provides one-step rust treatment that destroys old rust, prevents new rust. Just brush or spray it on. Within minutes, rust disappears and is converted to a durable black protective coating. Surface rust must be present. Use as a primer or finish coat. Specially formulated to be used with body filler and fiberglass.

Typical Applications: Aerosol can is ideal for hard-to-reach automotive applications.

Item	Container Size	Pack
633877	10.25 oz. aerosol can	12
1381192	8 oz. bottle	6
234981	1 qt bottle	10

LOCTITE® HEAVY-DUTY RUBBERIZED UNDERCOATING

This heavy-duty undercoating seals, protects and insulates. Rubberized for maximum durability. Excellent professional blend, all-purpose coating.

Typical Applications: Automotive frames, rocker panels, and wheels.

Item	Container Size	Pack
502908	16 oz. aerosol can	12



LOCTITE® NAVAL JELLY® RUST DISSOLVER

The original rust treatment formula that has been used for over 25 years. It removes rust from metal surfaces such as iron and steel. Can be applied on metal surfaces by brushing or spraying.

Typical Applications: Iron railings, barbecue grills, automobiles, patio furniture, tools, antiques, mailboxes, lawn mowers, bicycles & lamp posts.

Item	Container Size	Pack
1381191	8 oz. bottle	6



SPECIALTY PRODUCTS



LOCTITE® PC 3967™ STRIPPED THREAD REPAIR KIT

Makes reliable thread repairs without drills, taps, tools or inserts. Restores worn, stripped or damaged threads and eliminates future corrosion, galling, seizing and rust. Allows up to 128 ft. lbs. of torque between -65°F and 300°F (-54°C and 149°C). Permanently repairs stripped threads and fasteners in five minutes (up to SAE Grade 5 English and 8.8 metric).

Typical Applications: Intake manifold bracket fastener threads, timing chain cover bolt threads, valve cover bolt threads, water pump bolt threads.

Item	Container Size	Pack
236382	4.8 ml kit	6



LOCTITE® INSULATING & SEALING WRAP

LOCTITE® Insulating & Sealing Wrap is a non-sticky, self-fusing, multi-purpose wrap that stretches three times its size. Great for quick fixes anywhere, any time.

Typical Applications: Jumper cable grip/insulating, emergency hose repair, exhaust wrap, tool handles.

Item	Container Size	Color	Pack
1212164	1" x 10' roll	Red	10
1540599	1" x 10' roll	Black	10



LOCTITE® SF 7617™ INDUSTRIAL HAND WIPES

Pre moistened 9.5" x 12" wipe. Abrasive enough to scrub off the toughest grease and grime without scratching hands or paint.

Typical Applications: Removal of dried bugs from windshields, hoods and radiator grills. Cleans commercial working hands without water.

Item	Container Size	Pack
337637	75 count canister	6
337638	130 count bucket	4



LOCTITE® PC 4400™ PAINT PROTECT & RESTORE COATING

A one-part clear coating that can be applied directly over existing paint on a vehicle to extend its life and restore it to look like new. It can be spray applied or wiped on, offering excellent flow and leveling.

Typical Applications: Exterior finishes of vehicles including agricultural, construction, mining, buses, rail, military, delivery trucks, forestry and specialty fleet vehicles.

Item	Container Size	Pack
2573885	1 L bottle	4
2573975	3.8 L jug	2



LOCTITE® LEATHER & VINYL REPAIR KIT

LOCTITE® Leather, Vinyl & Plastic Repair kit is the perfect solution for mending holes, rips, and burns. The system is easy to use and requires to neat. Any color can be matched through proper mixing, and the product cures in just 30 minutes.

Typical Applications: All flexible materials including: seats, dashboards, door panels, and vinyl tops.

Item	Container Size	Pack
2445836	1.25 fl. oz.	6

LOCTITE® PC 4401™ MATTE ADDITIVE FOR PC 4400™

Matting effect and increases hardness of coating from 4H to 7H.

Item	Container Size	Pack
2573869	1.1 L bottle	4

LOCTITE® PC 4402™ ACCELERATOR ADDITIVE FOR PC 4400™

Accelerate dust & tack free times of PC 4400™

Item	Container Size	Pack
2573973	120 ml bottle	6

AUTOMOBILE ENGINE

LOCTITE® RTV 5699™ Grey Silicone Gasket Maker
Water Pump and Thermostat Housing Gasket

LOCTITE® 565™ Thread Sealant
Water Temperature Sending Unit Gasket

LOCTITE® RTV 587™ Blue Silicone Gasket Maker
Intake Manifold

LOCTITE® RTV 5920™ Copper Silicone Gasket Maker
Water Pump Gasket

LOCTITE® RTV Blue Silicone Gasket Maker
Timing Chain Cover Gasket

LOCTITE® RTV 587™ Blue Silicone Gasket Maker
Oil Pan Gasket

LOCTITE® Blue Stick Threadlocker or LOCTITE® Threadlocker 243™
Timing Chain Cover Bolts

LOCTITE® Aviation Gasket Sealant
Thermostat Hose Connection

LOCTITE® Copper Gasket Adhesive
Head Gasket

LOCTITE® Gasket Sealant 1
Intake Manifold Gasket

LOCTITE® Ready Gasket
Valve Cover Gasket

LOCTITE® Threadlocker 263™
Flywheel to Crank Shaft Bolts

LOCTITE® Dielectric Tune-Up Grease
Spark Plugs

LOCTITE® Copper Gasket Adhesive
Exhaust Manifold Gasket

LOCTITE® Blue Stick Threadlocker or LOCTITE® Threadlocker 243™
Oil Pan Bolts

LOCTITE® Blue Stick Threadlocker or LOCTITE® Threadlocker 243™
Transmission Fluid Pan Bolts

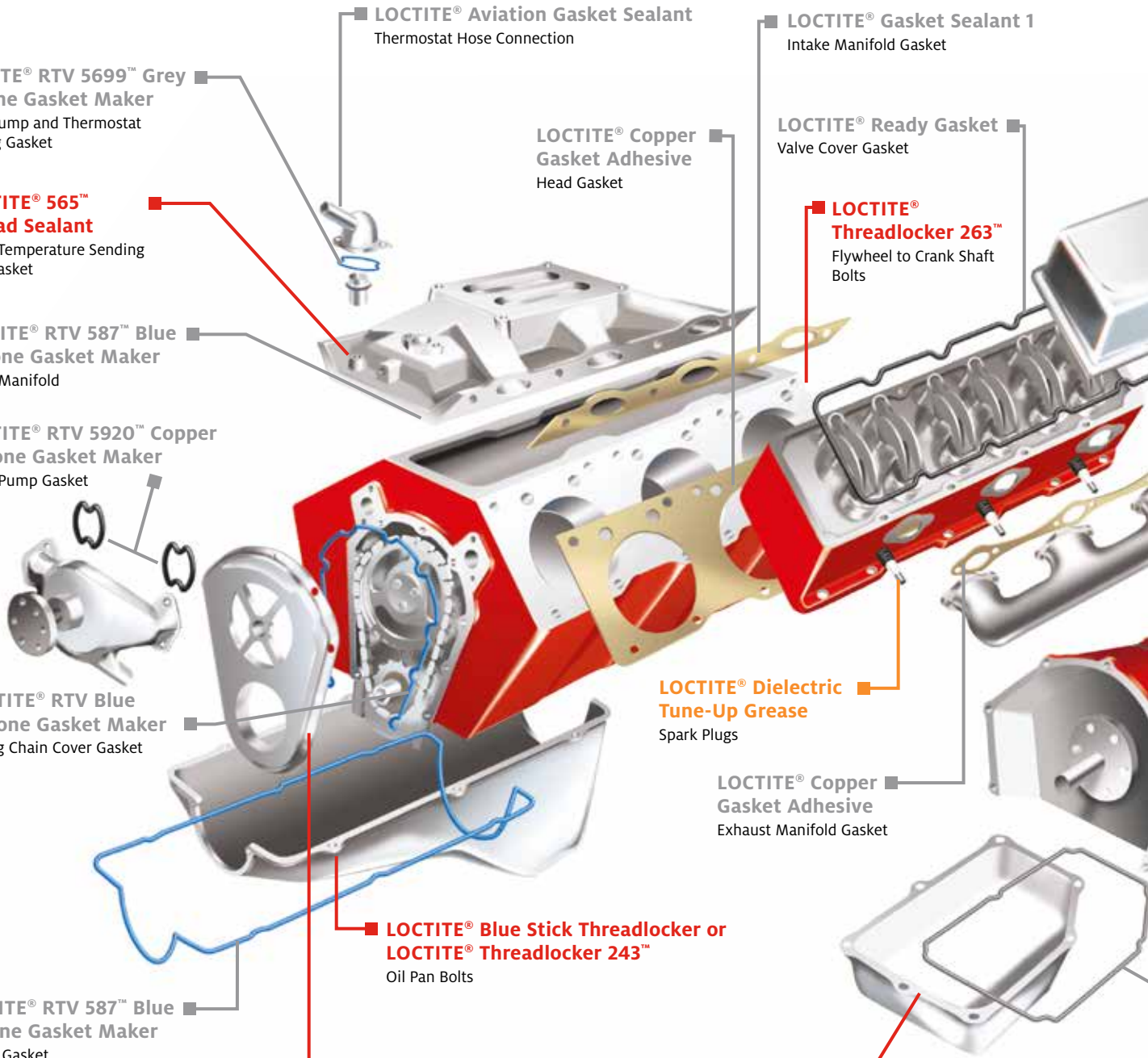

This diagram shows some of the many LOCTITE® product applications for automobile repairs. Most of these applications would also apply to heavy-duty vehicle or motorcycle repairs.

Log on to www.na.henkel-adhesives.com/aam and experience this application chart via our “Virtual Engine.”

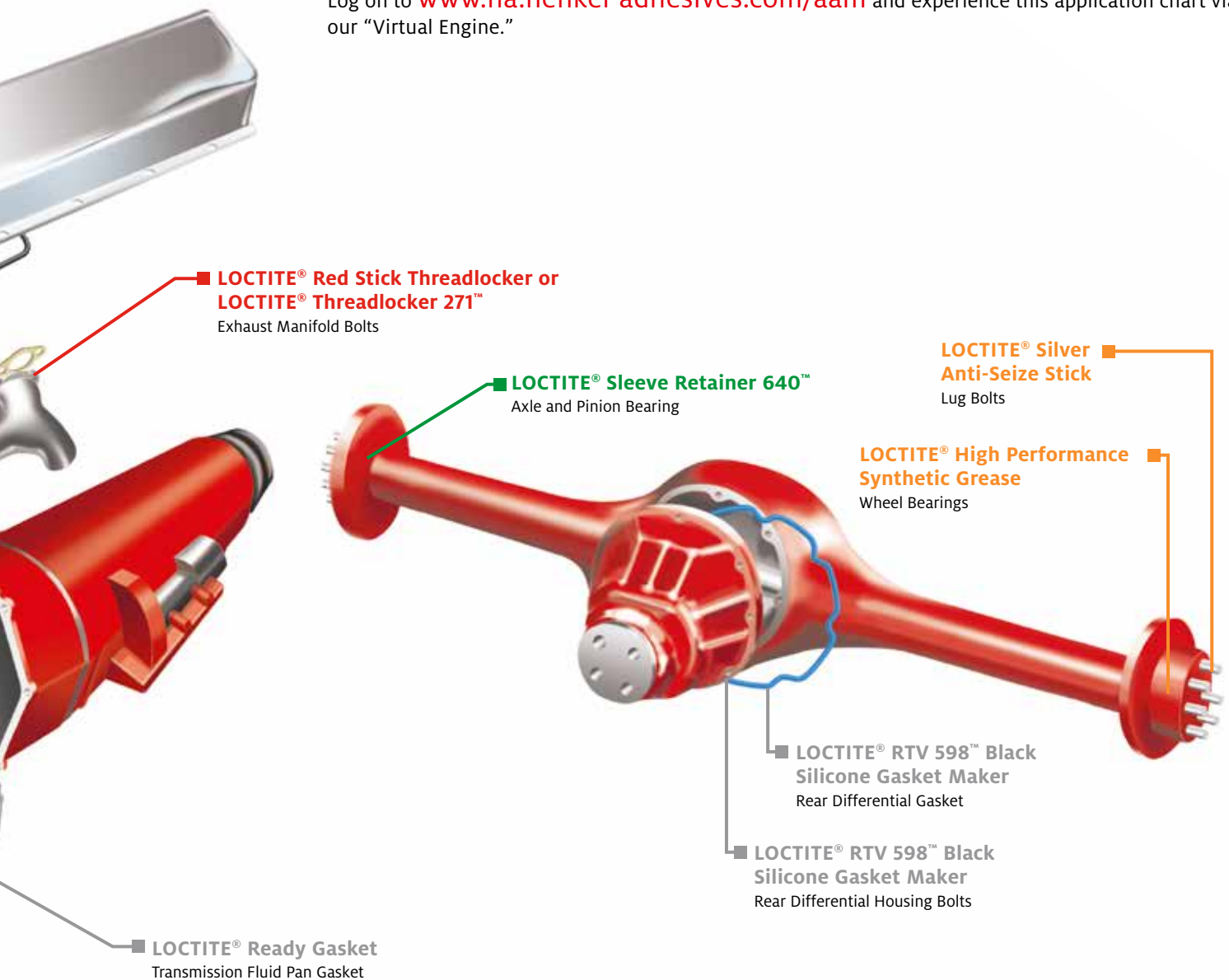

DIESEL ENGINE

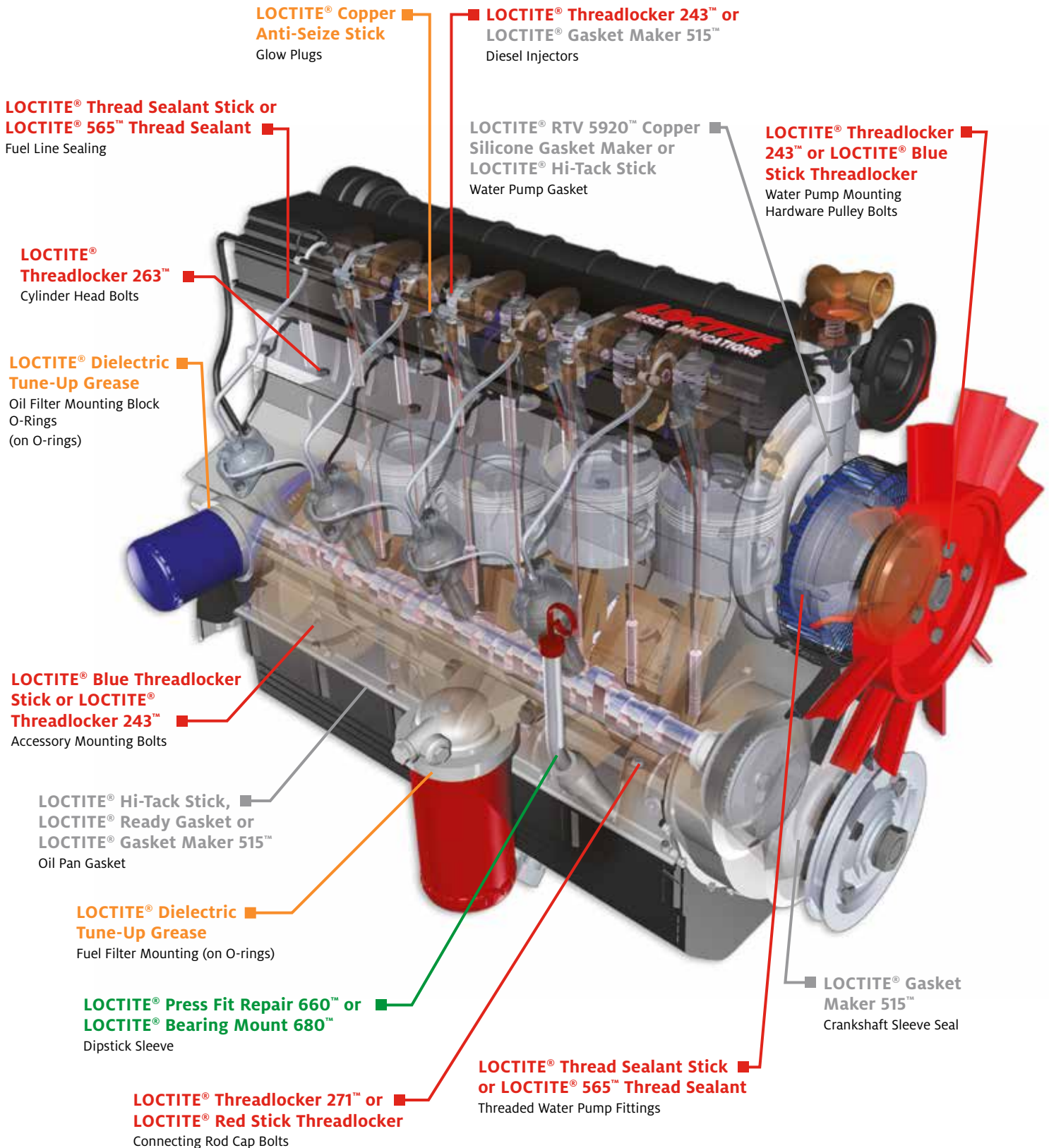

LOCTITE® Copper Anti-Seize Stick
Glow Plugs

LOCTITE® Threadlocker 243™ or LOCTITE® Gasket Maker 515™
Diesel Injectors

LOCTITE® Thread Sealant Stick or LOCTITE® 565™ Thread Sealant
Fuel Line Sealing

LOCTITE® RTV 5920™ Copper Silicone Gasket Maker or LOCTITE® Hi-Tack Stick
Water Pump Gasket

LOCTITE® Threadlocker 243™ or LOCTITE® Blue Stick Threadlocker
Water Pump Mounting Hardware Pulley Bolts

LOCTITE® Threadlocker 263™
Cylinder Head Bolts

LOCTITE® Dielectric Tune-Up Grease
Oil Filter Mounting Block O-Rings (on O-rings)

LOCTITE® Blue Threadlocker Stick or LOCTITE® Threadlocker 243™
Accessory Mounting Bolts

LOCTITE® Hi-Tack Stick, LOCTITE® Ready Gasket or LOCTITE® Gasket Maker 515™
Oil Pan Gasket

LOCTITE® Dielectric Tune-Up Grease
Fuel Filter Mounting (on O-rings)

LOCTITE® Press Fit Repair 660™ or LOCTITE® Bearing Mount 680™
Dipstick Sleeve

LOCTITE® Threadlocker 271™ or LOCTITE® Red Stick Threadlocker
Connecting Rod Cap Bolts

LOCTITE® Thread Sealant Stick or LOCTITE® 565™ Thread Sealant
Threaded Water Pump Fittings

LOCTITE® Gasket Maker 515™
Crankshaft Sleeve Seal

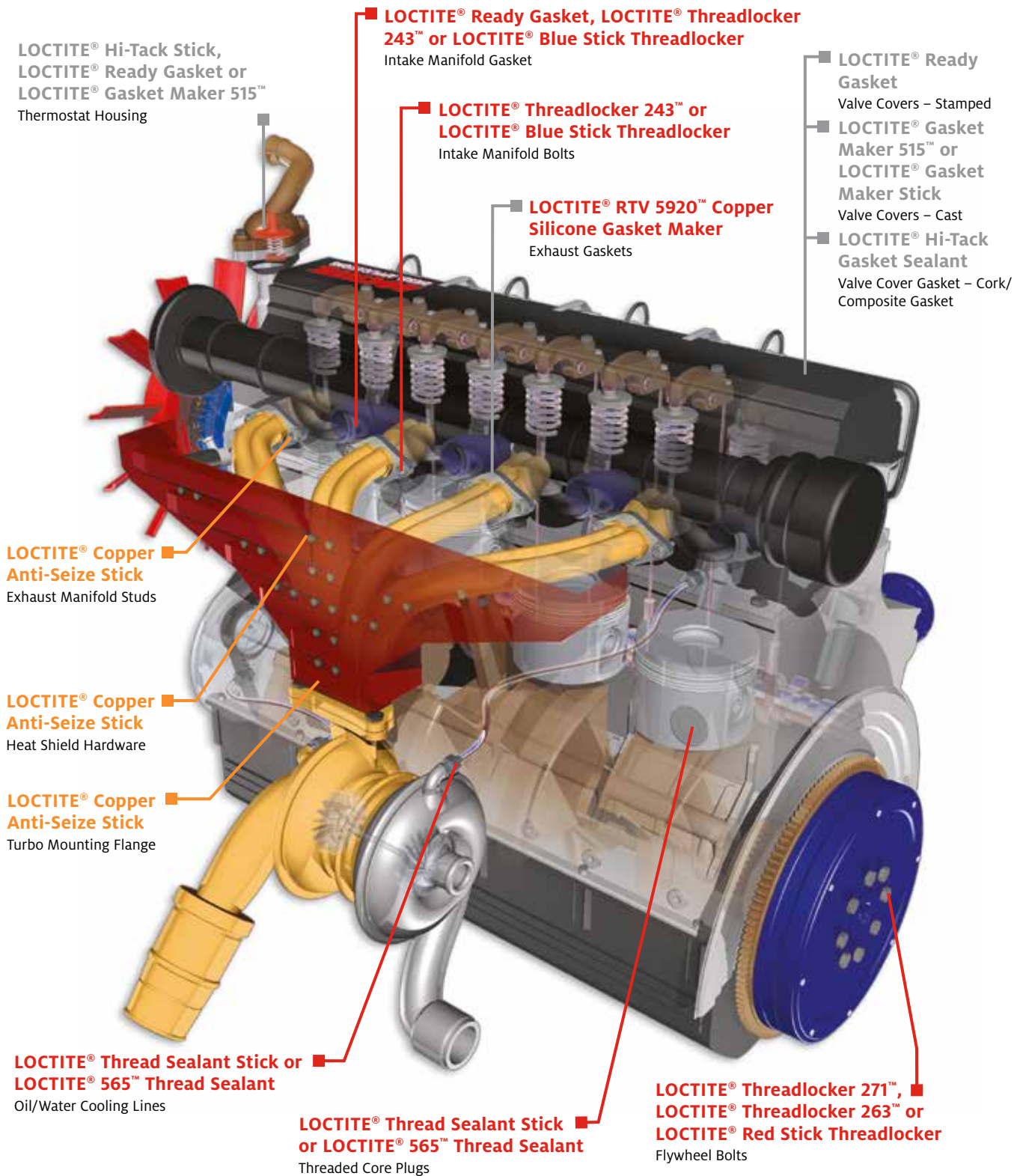

HEAVY-DUTY DIFFERENTIAL/AXLE

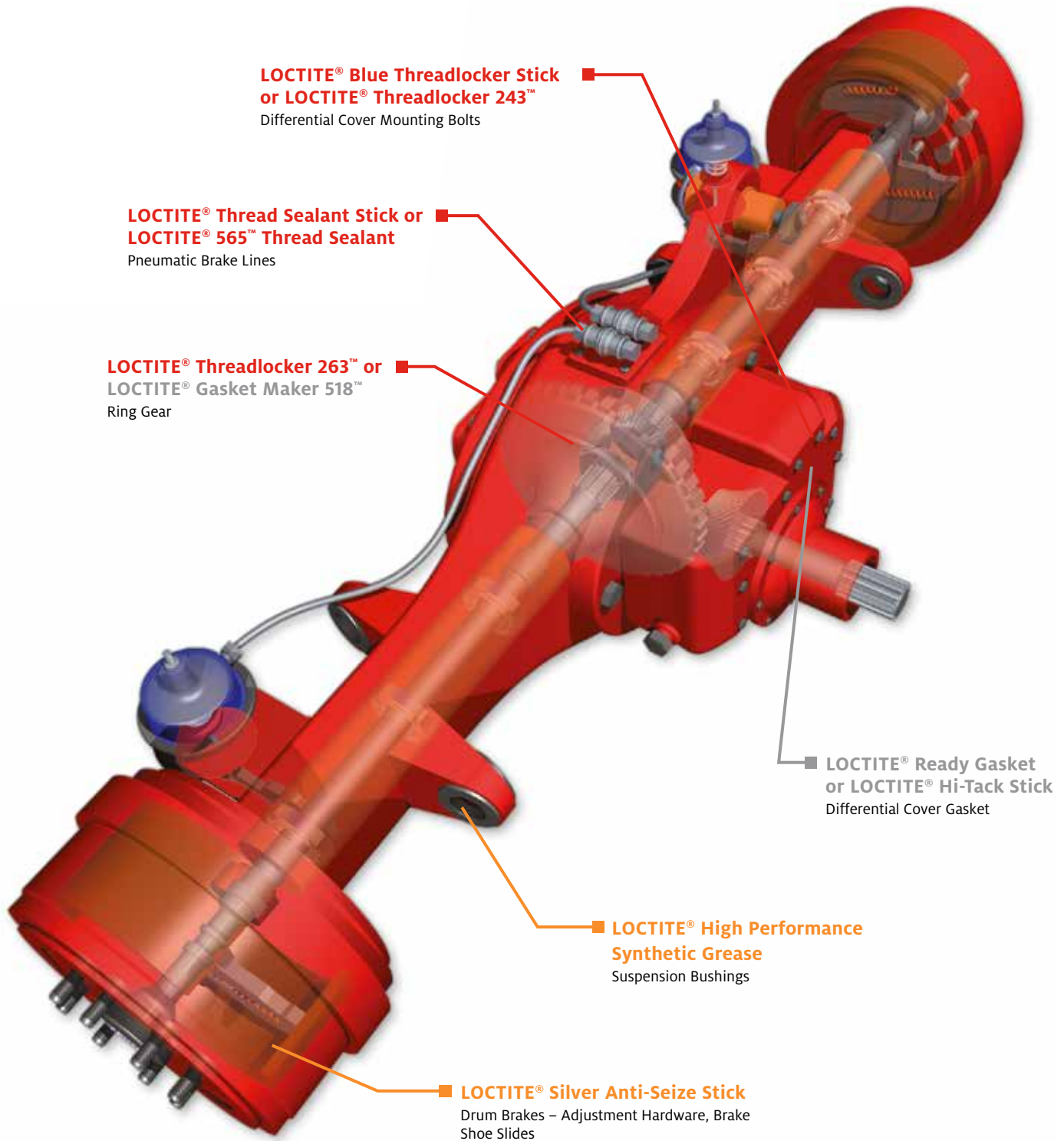

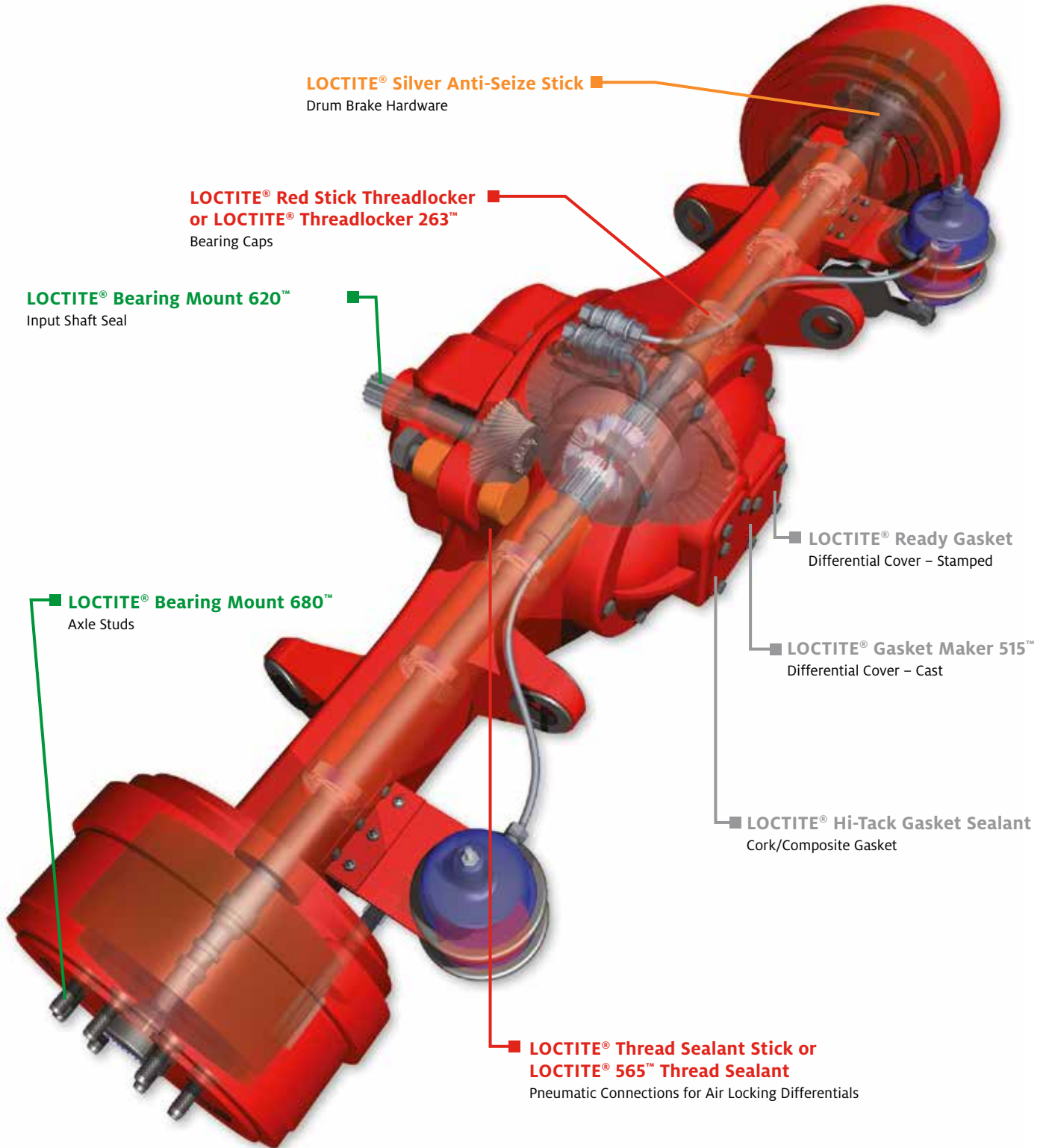

AUTOMOBILE TRANSMISSION

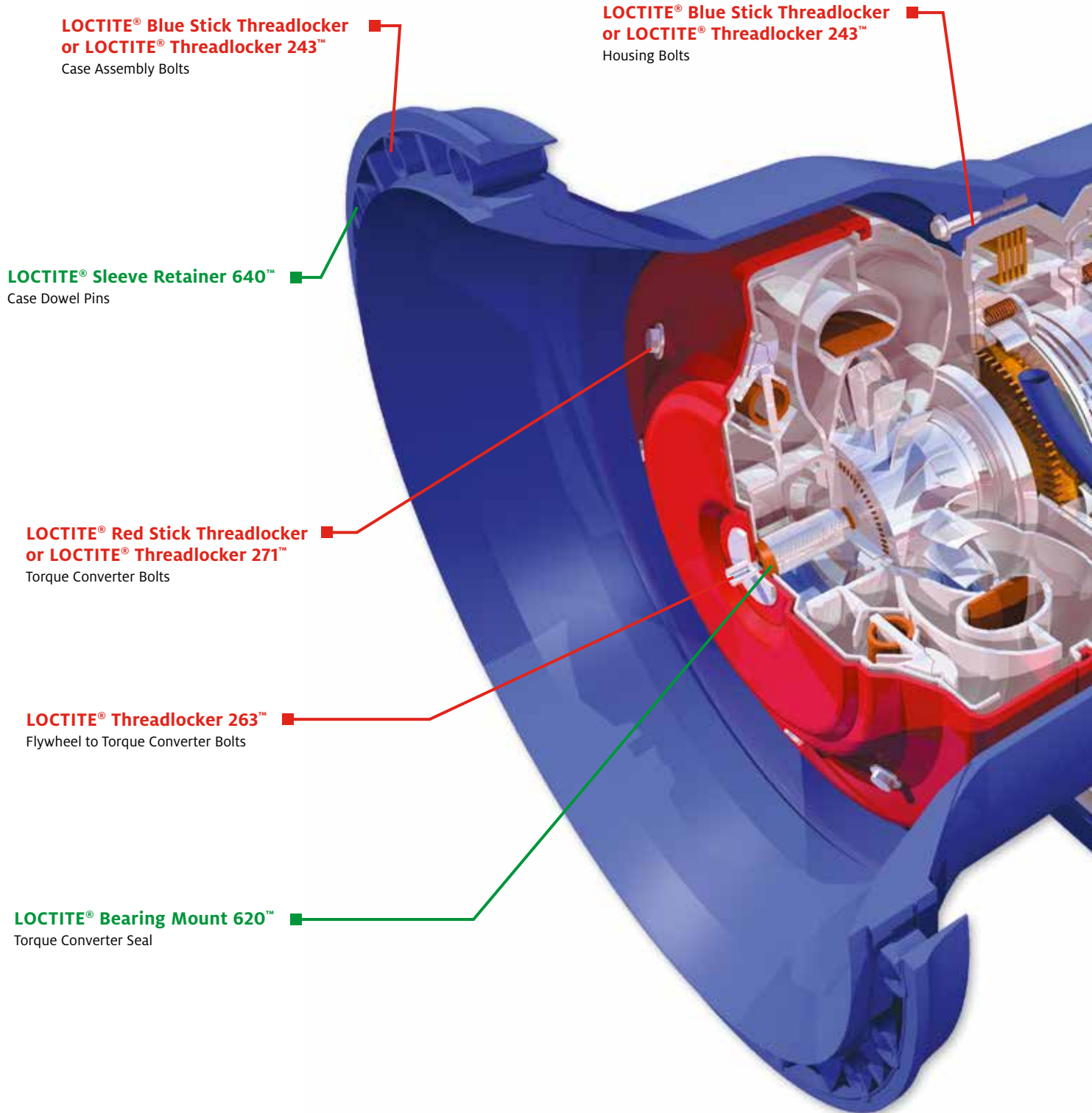

**LOCTITE® Blue Stick Threadlocker
or LOCTITE® Threadlocker 243™**
Case Assembly Bolts

**LOCTITE® Blue Stick Threadlocker
or LOCTITE® Threadlocker 243™**
Housing Bolts

LOCTITE® Sleeve Retainer 640™
Case Dowel Pins

**LOCTITE® Red Stick Threadlocker
or LOCTITE® Threadlocker 271™**
Torque Converter Bolts

LOCTITE® Threadlocker 263™
Flywheel to Torque Converter Bolts

LOCTITE® Bearing Mount 620™
Torque Converter Seal

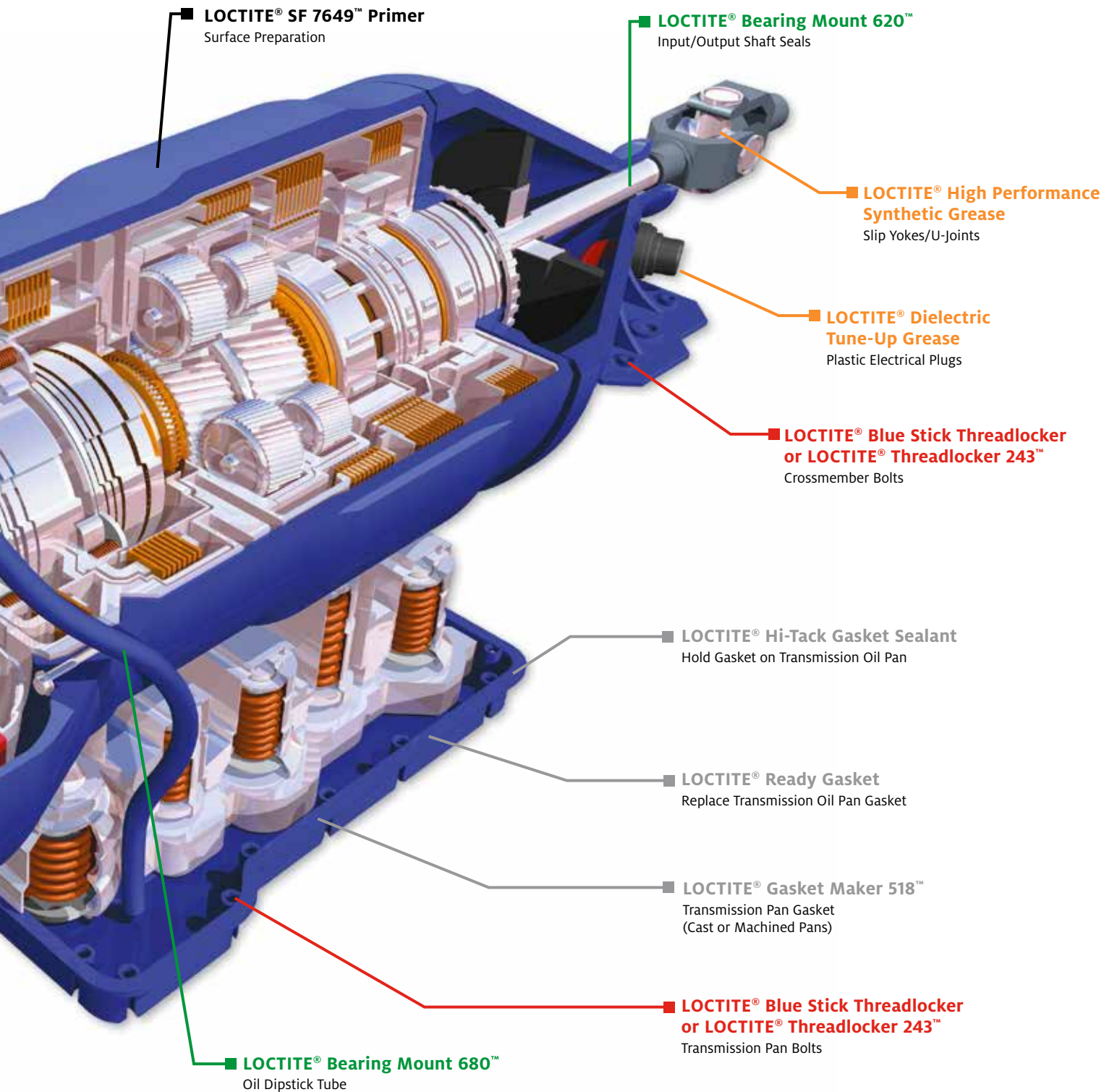

HEAVY-DUTY TRANSMISSION

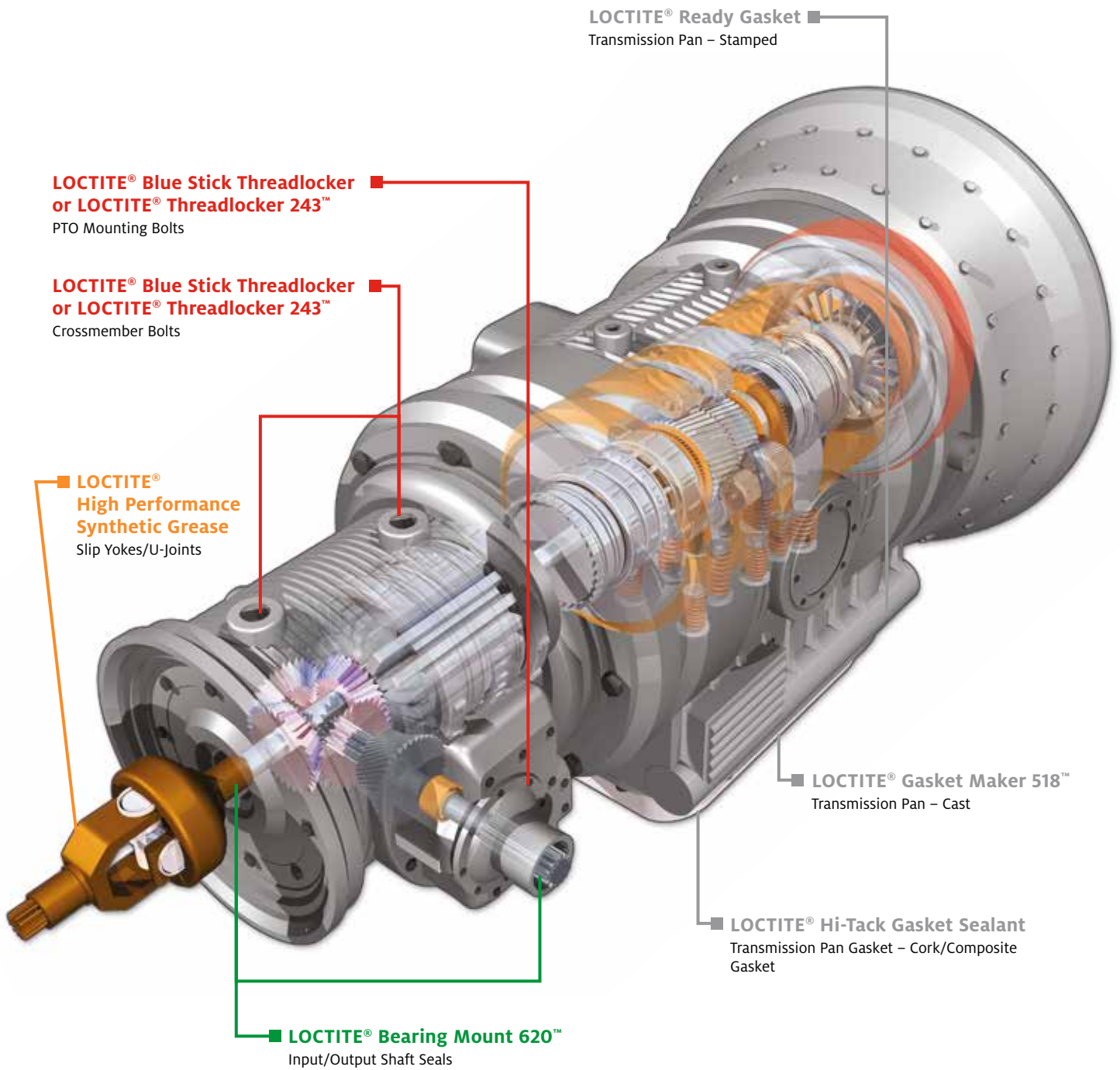

LOCTITE® Ready Gasket ■
Transmission Pan – Stamped

LOCTITE® Blue Stick Threadlocker
or LOCTITE® Threadlocker 243™ ■
PTO Mounting Bolts

LOCTITE® Blue Stick Threadlocker
or LOCTITE® Threadlocker 243™ ■
Crossmember Bolts

LOCTITE®
High Performance
Synthetic Grease ■
Slip Yokes/U-joints

LOCTITE® Bearing Mount 620™ ■
Input/Output Shaft Seals

LOCTITE® Gasket Maker 518™ ■
Transmission Pan – Cast

LOCTITE® Hi-Tack Gasket Sealant ■
Transmission Pan Gasket – Cork/Composite
Gasket

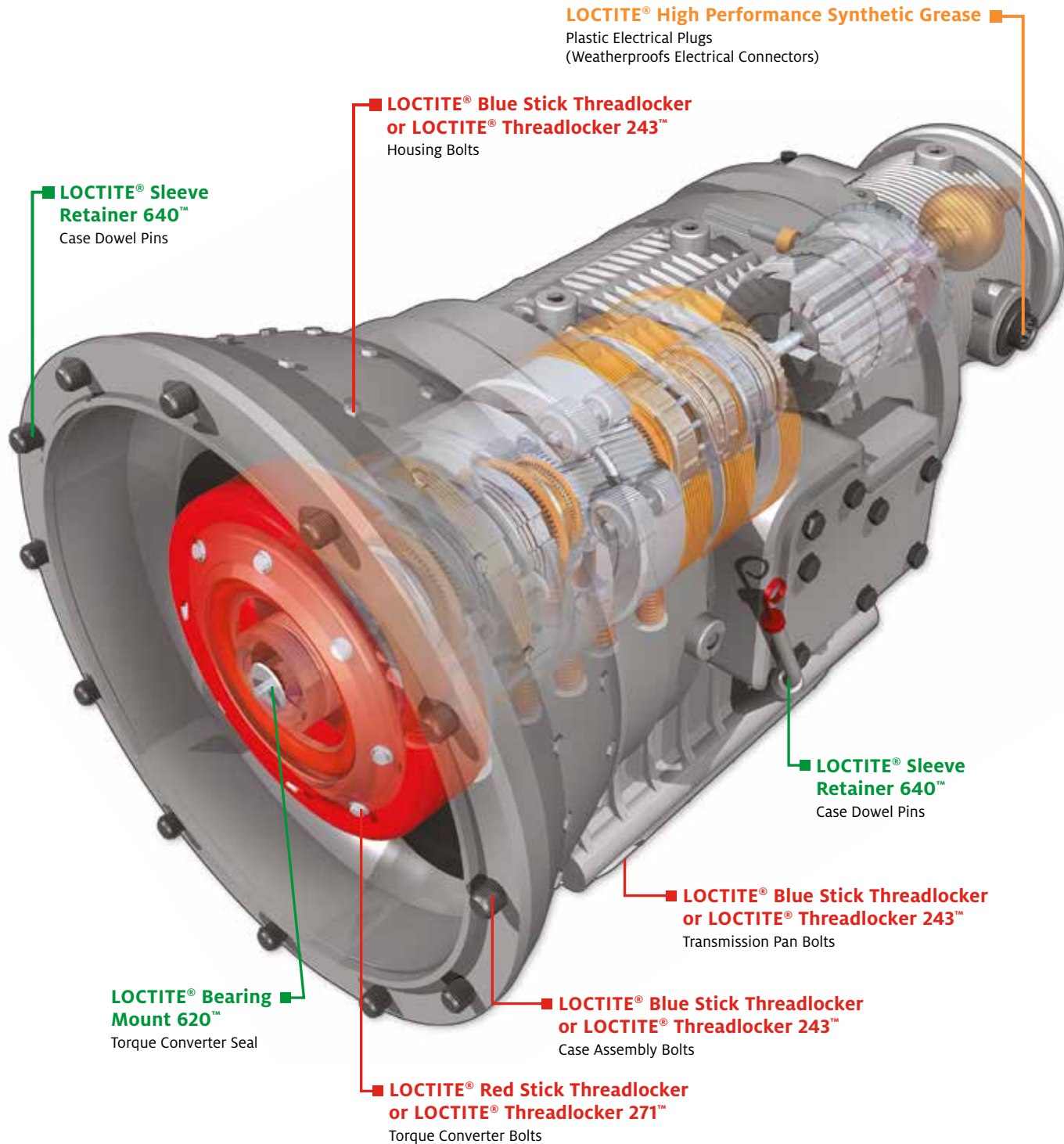

HEAVY-DUTY SUSPENSION

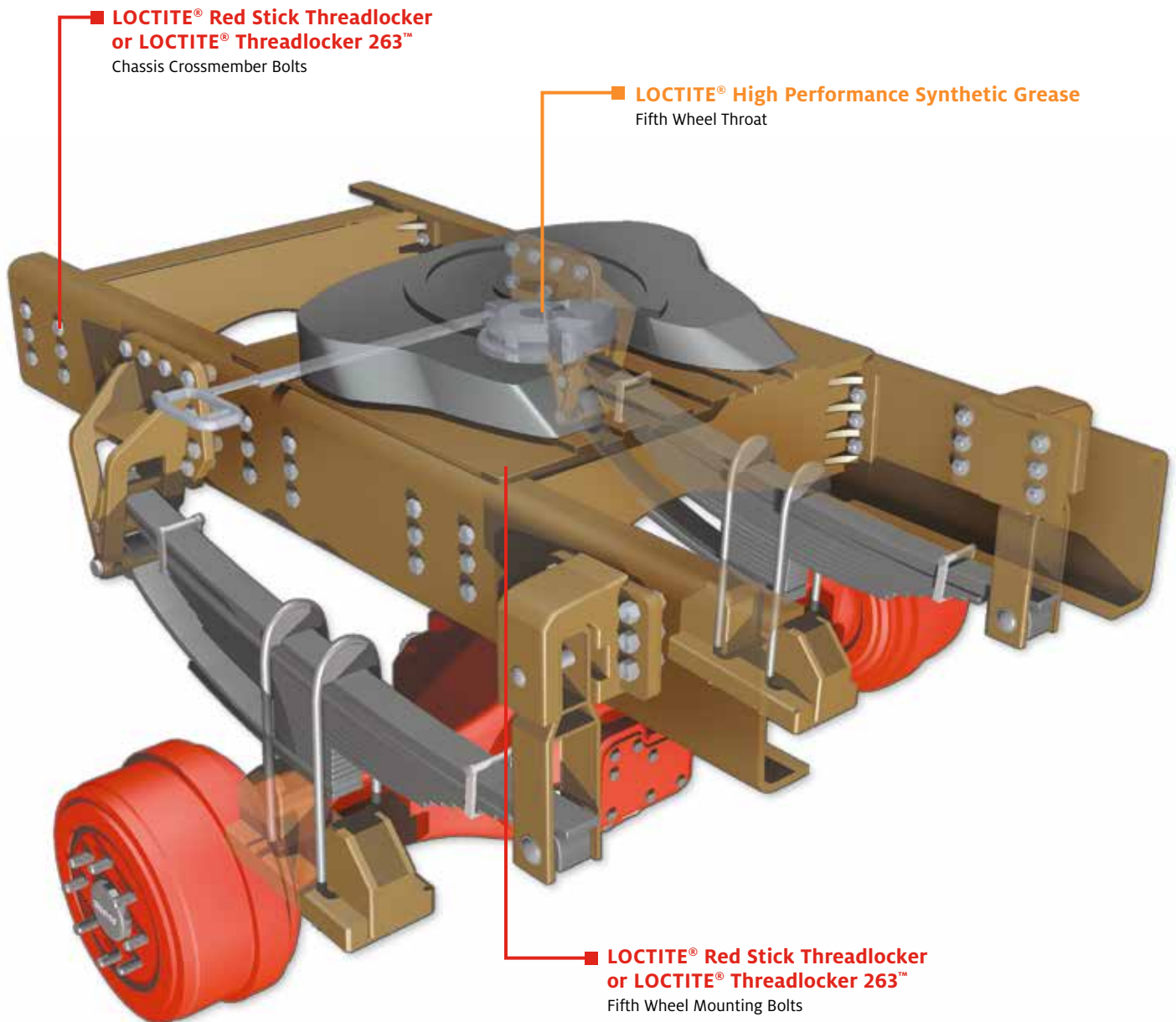

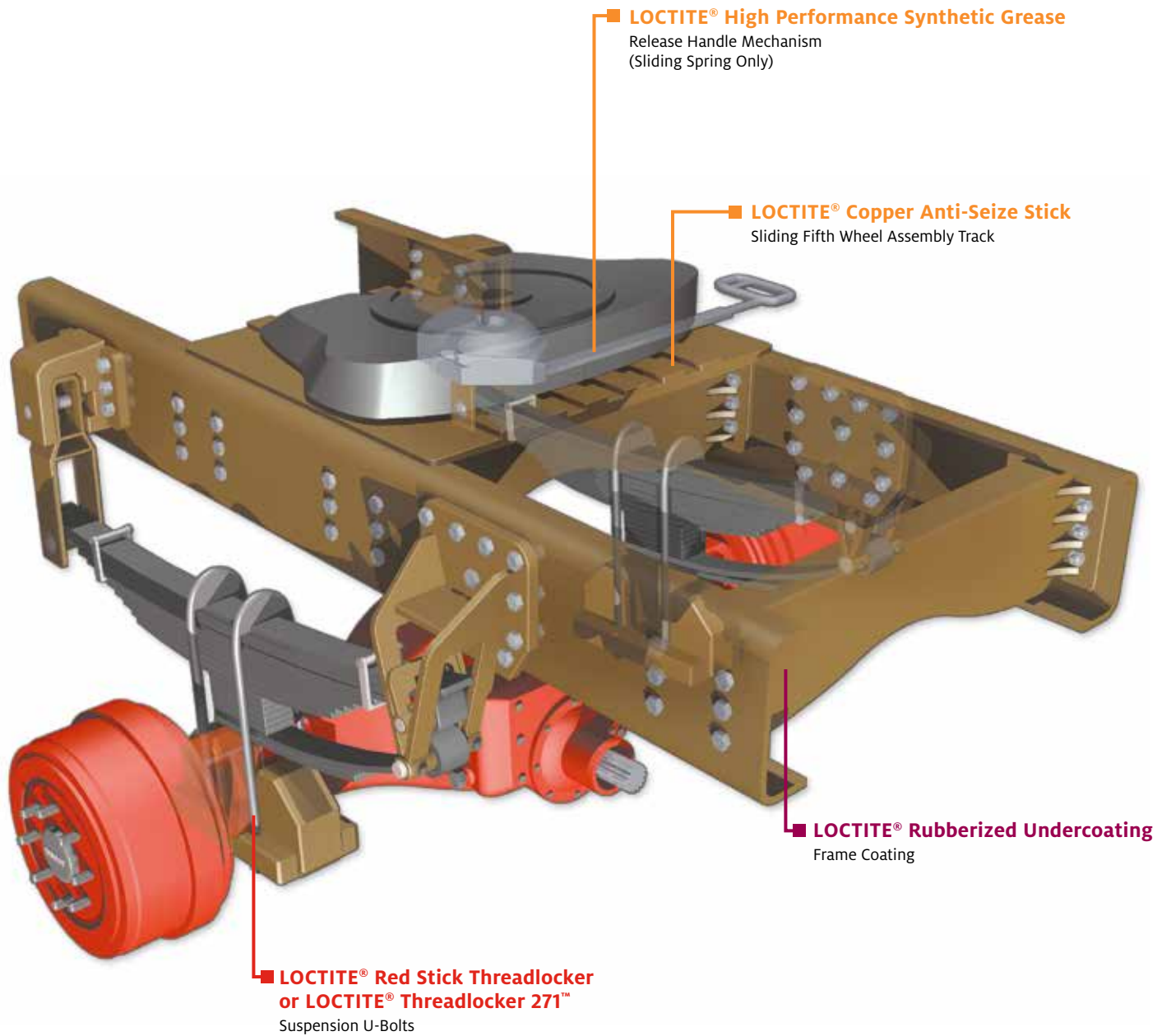

MOTORCYCLE CHASSIS

LOCTITE® Blue Stick Threadlocker or LOCTITE® Threadlocker 243™
Handlebar Brackets

LOCTITE® Dielectric Grease
Headlight Bulbs

LOCTITE® Dielectric Grease
All Light Bulbs

LOCTITE® Blue Stick Threadlocker or LOCTITE® Threadlocker 243™
Mirror Fixtures

LOCTITE® Threadlocker 222™
Throttle Control Grip Screw

LOCTITE® Disc Brake Quiet Stick
Brake Caliper and Pads

LOCTITE® Blue Stick Threadlocker or LOCTITE® Threadlocker 243™
Clutch Inspection Cover Bolts

LOCTITE® RTV 598™ Black Silicone Gasket Maker
Clutch Release Cover

LOCTITE® Blue Stick Threadlocker or LOCTITE® Threadlocker 243™
Coil Cover Screws

LOCTITE® Blue Stick Threadlocker or LOCTITE® Threadlocker 243™
Shifter Bracket Bolts

LOCTITE® High Performance Synthetic Grease
Slide Bolts

LOCTITE® Blue Stick Threadlocker or LOCTITE® Threadlocker 243™
Shock Bolts

LOCTITE® Blue Stick Threadlocker or LOCTITE® Threadlocker 243™
Rear Fender Nuts

LOCTITE® Blue Stick Threadlocker or LOCTITE® Threadlocker 243™
Rear Axle Adjuster Bolts

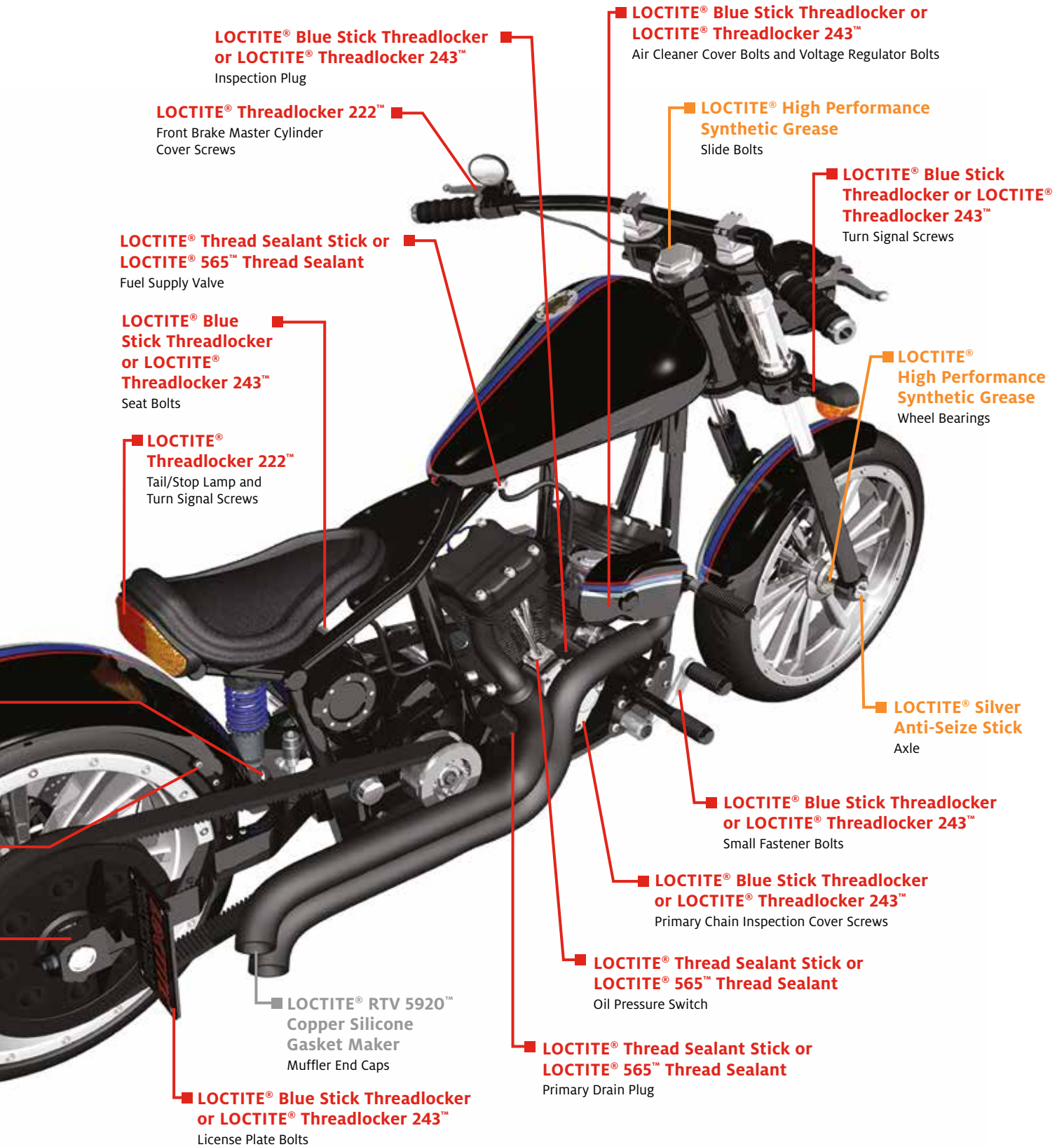

LOCTITE® Blue Stick Threadlocker or LOCTITE® Threadlocker 243™
Inspection Plug

LOCTITE® Threadlocker 222™
Front Brake Master Cylinder
Cover Screws

LOCTITE® Thread Sealant Stick or LOCTITE® 565™ Thread Sealant
Fuel Supply Valve

LOCTITE® Blue Stick Threadlocker or LOCTITE® Threadlocker 243™
Seat Bolts

LOCTITE® Threadlocker 222™
Tail/Stop Lamp and
Turn Signal Screws

LOCTITE® Blue Stick Threadlocker or LOCTITE® Threadlocker 243™
Air Cleaner Cover Bolts and Voltage Regulator Bolts

LOCTITE® High Performance Synthetic Grease
Slide Bolts

LOCTITE® Blue Stick Threadlocker or LOCTITE® Threadlocker 243™
Turn Signal Screws

LOCTITE® High Performance Synthetic Grease
Wheel Bearings

LOCTITE® Silver Anti-Seize Stick
Axle

LOCTITE® Blue Stick Threadlocker or LOCTITE® Threadlocker 243™
Small Fastener Bolts

LOCTITE® Blue Stick Threadlocker or LOCTITE® Threadlocker 243™
Primary Chain Inspection Cover Screws

LOCTITE® Thread Sealant Stick or LOCTITE® 565™ Thread Sealant
Oil Pressure Switch

LOCTITE® Thread Sealant Stick or LOCTITE® 565™ Thread Sealant
Primary Drain Plug

LOCTITE® RTV 5920™ Copper Silicone Gasket Maker
Muffler End Caps

LOCTITE® Blue Stick Threadlocker or LOCTITE® Threadlocker 243™
License Plate Bolts

MOTORCYCLE ENGINE

LOCTITE® Blue Stick Threadlocker or LOCTITE® Threadlocker 243™
Exhaust Flange Nuts

LOCTITE® Dielectric Tune-Up Grease
All Plug Wires and Electrical Connections

LOCTITE® Blue Stick Threadlocker or LOCTITE® Threadlocker 243™
Rocker Cover Bolts

LOCTITE® Silver Anti-Seize Stick or LOCTITE® Anti-Seize Lubricant – Silver
Spark Plugs

LOCTITE® Gasket Maker 515™
Valve Cover

LOCTITE® Copper Anti-Seize Stick or LOCTITE® Anti-Seize Lubricant – Copper
Exhaust Manifold Studs

LOCTITE® Silver Anti-Seize Stick or LOCTITE® Anti-Seize Lubricant – Silver
Spark Plugs

LOCTITE® Red Stick Threadlocker or LOCTITE® Threadlocker 263™
Drive Sprocket Retaining Nuts

LOCTITE® Thread Sealant Stick or LOCTITE® 565™ Thread Sealant
Oil Line Fittings

LOCTITE® Red Stick Threadlocker or LOCTITE® Threadlocker 263™
Crankcase Bolts

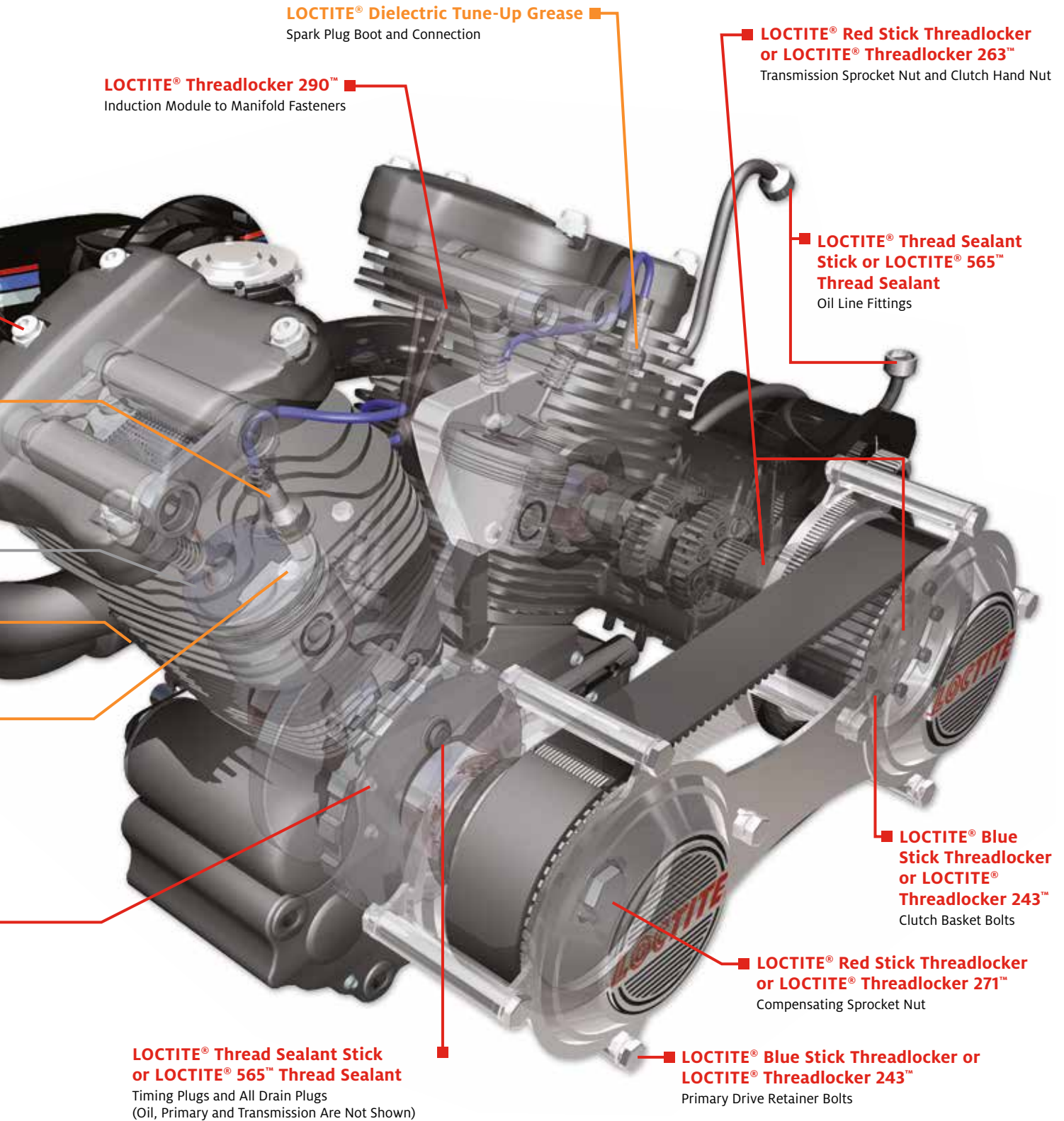

LOCTITE® Dielectric Tune-Up Grease

Spark Plug Boot and Connection

LOCTITE® Threadlocker 290™

Induction Module to Manifold Fasteners

LOCTITE® Red Stick Threadlocker or LOCTITE® Threadlocker 263™

Transmission Sprocket Nut and Clutch Hand Nut

LOCTITE® Thread Sealant Stick or LOCTITE® 565™ Thread Sealant

Oil Line Fittings

LOCTITE® Blue Stick Threadlocker or LOCTITE® Threadlocker 243™

Clutch Basket Bolts

LOCTITE® Red Stick Threadlocker or LOCTITE® Threadlocker 271™

Compensating Sprocket Nut

LOCTITE® Thread Sealant Stick or LOCTITE® 565™ Thread Sealant

Timing Plugs and All Drain Plugs
(Oil, Primary and Transmission Are Not Shown)

LOCTITE® Blue Stick Threadlocker or LOCTITE® Threadlocker 243™

Primary Drive Retainer Bolts

MARINE INBOARD ENGINE

LOCTITE® Threadlocker 222™

Throttle controls, electrical mounting plate screws, drive water pump screws, air box cover screws, neutral start switch screw, stator screws, cowl latch bolts

LOCTITE® Anti-Seize Lubricant – Copper **LOCTITE® Anti-Seize Lubricant – Silver**

Prop shaft splines, mechanical joints, starter bushings, battery terminals, dress exhaust gaskets, external metal parts, threads, gears, chains, cables, pulleys, rollers

LOCTITE® Thread Sealant Stick or **LOCTITE® 592™ Thread Sealant**

Hydraulic lines, oil sender and switch, water pressure sender, water temperature sender, bleed fittings, telltale fittings

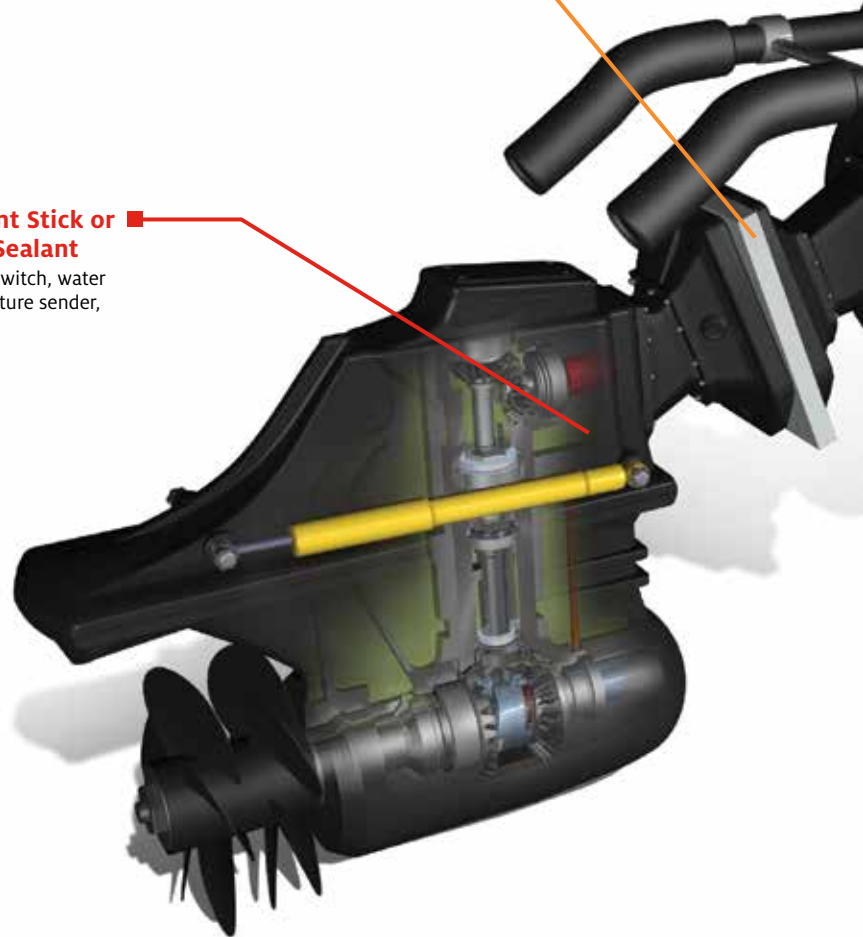

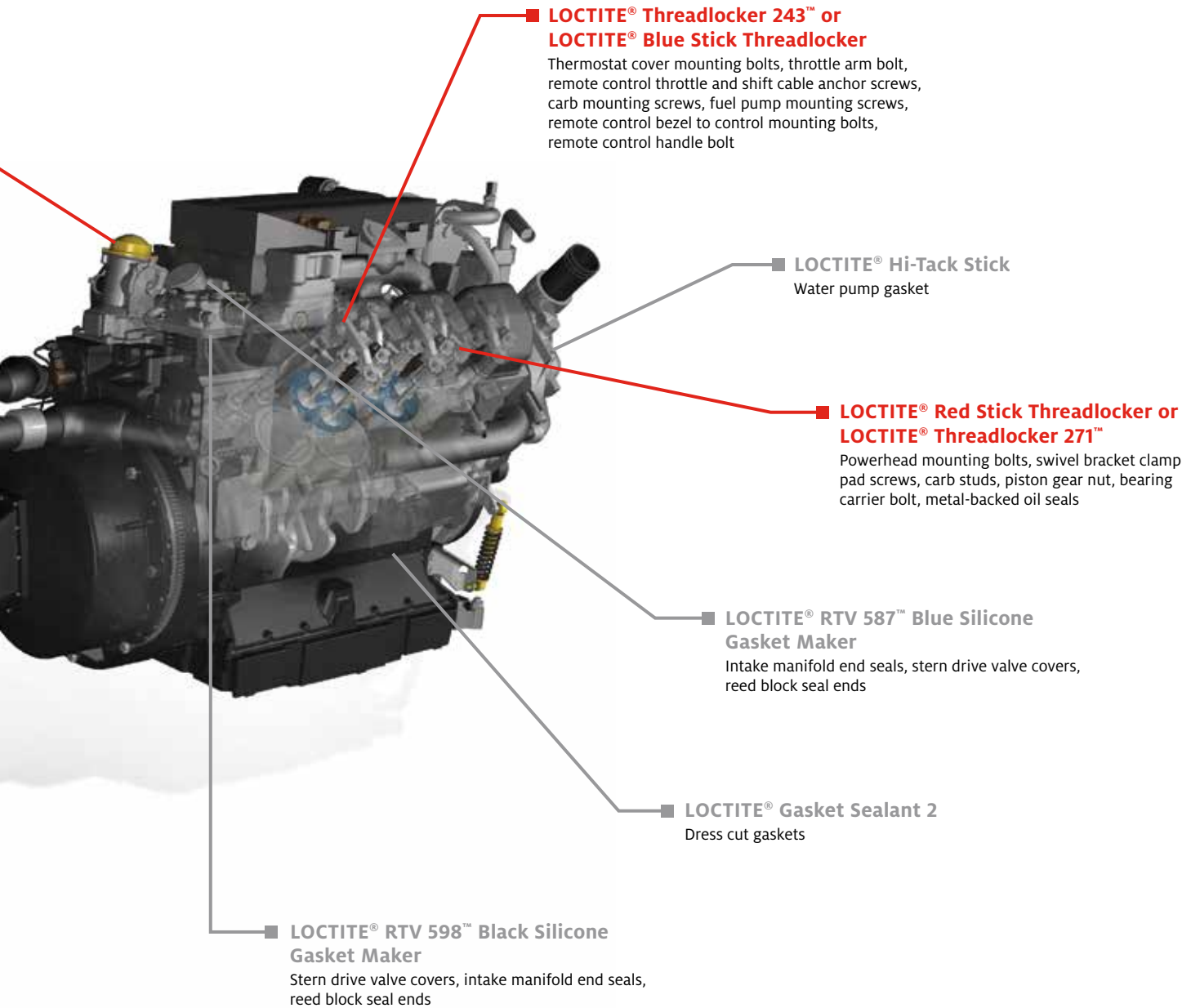

MARINE OUTBOARD ENGINE

**LOCTITE® Red Stick Threadlocker or
LOCTITE® Threadlocker 271™**

Piston gear nut, powerhead mounting bolts, swivel bracket clamp pad screws, carb studs, bearing carrier bolt, metal-backed oil seals

**LOCTITE® Threadlocker 243™ or
LOCTITE® Blue Stick Threadlocker**

Fuel pump mounting screws, thermostat cover mounting bolts, throttle arm bolt, remote control throttle and shift cable anchor screws, carb mounting screws, remote control bezel to control mounting bolts, remote control handle bolt

LOCTITE® Gasket Sealant 2

Dress cut gaskets

LOCTITE® Bearing Mount 680™

Powerhead mounting studs, rewind studs, drive shaft housing studs

LOCTITE® Hi-Tack Stick

Water pump gasket

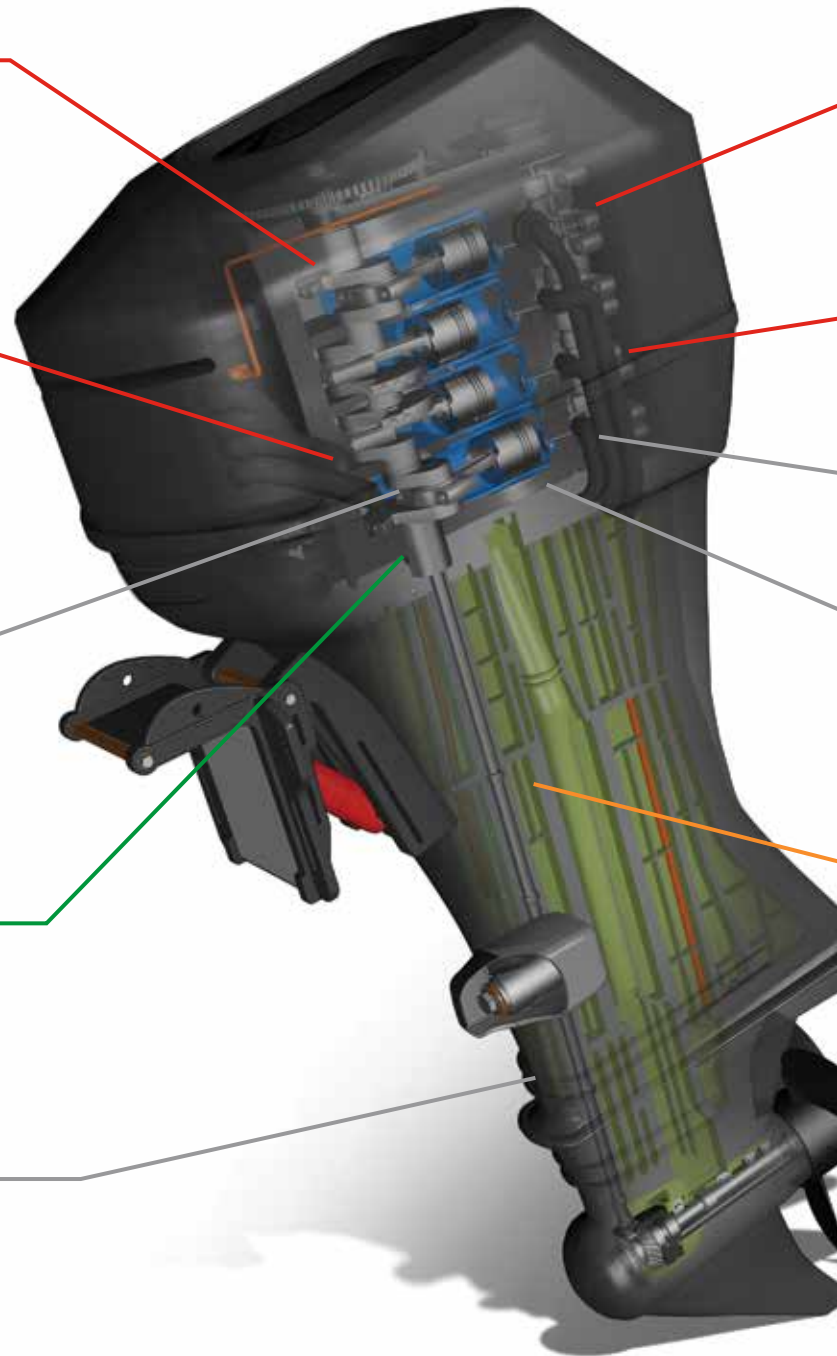



■ **LOCTITE® Thread Sealant Stick or
LOCTITE® 592™ Thread Sealant**

Hydraulic lines, oil sender and switch, water pressure sender, water temperature sender, bleed fittings, telltale fittings

■ **LOCTITE® Threadlocker 222™**

Stator screws, throttle controls, electrical mounting plate screws, drive water pump screws, air box cover screws, neutral start switch screw, cowl latch bolts

■ **LOCTITE® RTV 587™ Blue Silicone
Gasket Maker**

Intake manifold, valve covers, reed block seal ends

■ **LOCTITE® Gasket Maker 518™**

Seal outboard crankcase halves

■ **LOCTITE® Anti-Seize Lubricant – Copper
LOCTITE® Anti-Seize Lubricant – Silver**

Prop shaft splines, mechanical joints, starter bushings, battery terminals, dress exhaust gaskets, external metal parts, threads, gears, chains, cables, pulleys, rollers

AGENCY APPROVALS

NSF International

NON-FOOD COMPOUND

LOCTITE® SF 7649™ Primer
 LOCTITE® Ready Gasket
 LOCTITE® RTV 587™ Blue Silicone Gasket Maker, High Performance
 LOCTITE® Threadlocker 242®, Medium Strength
 LOCTITE® Threadlocker 290™, Wicking Grade

STANDARD 51

LOCTITE® RTV Black Silicone, Adhesive/Sealant
 LOCTITE® RTV Clear Silicone, Adhesive/Sealant

H-1 RATING

LOCTITE® High Performance Synthetic Grease

American Bureau of Shipping (ABS)

LOCTITE® Anti-Seize Lubricant, Silver
 LOCTITE® Retaining Compound 620™, High Temperature
 LOCTITE® Retaining Compound 680™, Relaxed Fits
 LOCTITE® Extend® Rust Treatment
 LOCTITE® RTV 587™ Blue Silicone Gasket Maker, High Performance
 LOCTITE® RTV 598™ Black Silicone Gasket Maker, High Performance
 LOCTITE® Threadlocker 242®, Medium Strength
 LOCTITE® Threadlocker 262™, High Strength
 LOCTITE® Thread Sealant 545™, Pneumatic/Hydraulic

UL Classified/Listed for U.S.

LOCTITE® Gasket Maker 515™, Anaerobic
 LOCTITE® Thread Sealant 565™, High Performance
 LOCTITE® Thread Sealant 592™, High Temperature
 LOCTITE® RTV 587™ Blue Silicone Gasket Maker, High Performance
 LOCTITE® RTV Black Silicone, Adhesive/Sealant
 LOCTITE® RTV Clear Silicone, Adhesive/Sealant
 LOCTITE® Thread Sealant Stick
 LOCTITE® Threadlocker 271™, Heavy-Duty

ULC Classified for Canada

LOCTITE® Thread Sealant 565™, High Performance
 LOCTITE® Thread Sealant, 592™ High Temperature
 LOCTITE® RTV Black Silicone, Adhesive/Sealant
 LOCTITE® RTV Clear Silicone, Adhesive/Sealant
 LOCTITE® Thread Sealant Stick

CSA International

LOCTITE® Thread Sealant 565™, High Performance
 LOCTITE® Thread Sealant Stick

Canadian Food Inspection Agency (CFIA)

LOCTITE® Anti-Seize Lubricant, Silver
 LOCTITE® Anti-Seize Lubricant, Silver, Aerosol Can
 LOCTITE® Aviation Gasket Sealant
 LOCTITE® Retaining Compound 620™, High Temperature
 LOCTITE® Retaining Compound 660™, For Worn Parts
 LOCTITE® Retaining Compound 680™, Relaxed Fits
 LOCTITE® Belt Dressing & Conditioner
 LOCTITE® Black Weatherstrip Adhesive
 LOCTITE® Blue Stick Threadlocker, Medium Strength
 LOCTITE® Copper Anti-Seize Stick
 LOCTITE® Extend® Rust Treatment
 LOCTITE® Gasket Maker 518™, Anaerobic
 LOCTITE® Gasket Sealant 1
 LOCTITE® SF 7649™ Primer
 LOCTITE® Penetrating Oil
 LOCTITE® Thread Sealant 565™, High Performance
 LOCTITE® Thread Sealant 592™, High Temperature
 LOCTITE® RTV 587™ Red Stick Threadlocker, High Strength
 LOCTITE® Blue Silicone Gasket Maker, High Performance
 LOCTITE® RTV 598™ Black Silicone Gasket Maker, High Performance
 LOCTITE® RTV 5699™ Grey Silicone Gasket Maker, High Performance
 LOCTITE® RTV Black Silicone, Adhesive/Sealant
 LOCTITE® RTV Clear Silicone, Adhesive/Sealant
 LOCTITE® RTV Red Silicone Gasket Maker, Sensor-Safe/High Temperature
 LOCTITE® Silicone Lubricant
 LOCTITE® Silver Anti-Seize Stick
 LOCTITE® Threadlocker 222™, Low Strength
 LOCTITE® Threadlocker 242®, Medium Strength
 LOCTITE® Threadlocker 243™, Surface Insensitive
 LOCTITE® Threadlocker 271™, Heavy-Duty
 LOCTITE® Threadlocker 277™, Heavy-Duty/Large Bolts
 LOCTITE® Threadlocker 290™, Penetrating
 LOCTITE® Threadlocker 262™, High Strength
 LOCTITE® Thread Sealant 545™, Pneumatic/Hydraulic
 LOCTITE® Thread Sealant Stick
 LOCTITE® Thread Sealant with PTFE
 LOCTITE® High Performance Synthetic Grease, Aerosol
 LOCTITE® Yellow Weatherstrip Adhesive
 LOCTITE® Blue Threadlocker Tape 249™, Medium Strength

Military Specifications (Mil Spec)

LOCTITE® Retaining Compound 640™, High Strength
 LOCTITE® SF 7649™ Primer
 LOCTITE® Threadlocker 222™, Low Strength
 LOCTITE® Threadlocker 242®, Medium Strength
 LOCTITE® Threadlocker 262™, High Strength
 LOCTITE® Threadlocker 271™, Heavy-Duty
 LOCTITE® Threadlocker 277™, Heavy-Duty/Large Bolts
 LOCTITE® Threadlocker 290™, Penetrating

INDEX BY PART NUMBER

Item Number	Legacy Number	Product Name	Container Size	Page(s)
228190	03325	LOCTITE® Rearview Mirror Adhesive	24 ml kit	17
236971	03346	LOCTITE® Rearview Mirror Adhesive	6 ml kit	17
194080	21351	LOCTITE® Rear Window Defogger	0.03 fl. oz. kit	17
236382	28654	LOCTITE® Form-A-Thread® Stripped Thread Repair Kit	4.8 ml syringe	35
275026	34026	LOCTITE® Marine Grade Anti-Seize	16 oz. brushtop can	30
299175	34395	LOCTITE® Marine Grade Anti-Seize	8 oz. brushtop can	30
337637	34943	LOCTITE® Industrial Hand Wipes	75 count	35
337638	34944	LOCTITE® Industrial Hand Wipes	130 count	35
483624	37391	LOCTITE® Quick Gel® Super Glue	2 g tube	17
483629	37396	LOCTITE® Thread Sealant 565™	50 ml tube	12, 13
483630	37397	LOCTITE® Thread Sealant 592™	50 ml tube	12, 13
483631	37398	LOCTITE® Thread Sealant 592™	6 ml tube	12, 13
487229	37418	LOCTITE® Threadlocker 242®	6 ml tube	8, 11
487231	37420	LOCTITE® Threadlocker 262™	6 ml tube	8, 11
487232	37421	LOCTITE® Threadlocker 271™	6 ml tube	9, 11
487234	37423	LOCTITE® Threadlocker 290™	6 ml tube	9, 11
487235	37424	LOCTITE® Sleeve Retainer 640™	6 ml tube	14, 15
487236	37425	LOCTITE® SUPER GLUE	2 g tube	20
487865	37438	LOCTITE® Rearview Mirror Adhesive	0.3 cc kit	17
491979	37460	LOCTITE® RTV Black Silicone	80 ml tube	19
491980	37461	LOCTITE® RTV Blue Silicone Gasket Maker	80 ml tube	25, 29
491981	37463	LOCTITE® RTV Clear Silicone	80 ml tube	19

Item Number	Legacy Number	Product Name	Container Size	Page(s)
491982	37464	LOCTITE® RTV 5699™ Grey Silicone Gasket Maker	80 ml tube	24, 29
491983	37465	LOCTITE® RTV 587™ Blue Silicone Gasket Maker	80 ml tube	24, 29
491984	37466	LOCTITE® RTV 5920™ Copper Silicone Gasket Maker	80 ml tube	24, 29
491985	37467	LOCTITE® RTV 598™ Black Silicone Gasket Maker	80 ml tube	24, 29
492001	37469	LOCTITE® RTV Red Silicone Gasket Maker	80 ml tube	25, 29
492140	37477	LOCTITE® Threadlocker 242®	36 ml bottle	8, 11
492141	37478	LOCTITE® Threadlocker 262™	36 ml bottle	8, 11
492142	37479	LOCTITE® Threadlocker 271™	36 ml bottle	9, 11
492143	37480	LOCTITE® Threadlocker 272™	36 ml bottle	9, 11
492144	37481	LOCTITE® Threadlocker 290™	36 ml bottle	9, 11
492145	37482	LOCTITE® Thread Sealant 545™	36 ml bottle	12, 13
492147	37484	LOCTITE® Sleeve Retainer 640™	36 ml bottle	14, 15
494147	37509	LOCTITE® Klean 'N Prime™	4.5 oz. aerosol	10
494150	37512	LOCTITE® Ready Gasket	5 oz. can	25, 29
494151	37513	LOCTITE® Epoxy Mixer in Cups	10-4 g cups	19
495072	37516	LOCTITE® RTV 587™ Blue Silicone Gasket Maker	300 ml	24, 29
495074	37518	LOCTITE® RTV 598™ Black Silicone Gasket Maker	300 ml	24, 29
495075	37519	LOCTITE® RTV 598™ Black Silicone Gasket Maker	8.75 oz. can	24, 29
495076	37521	LOCTITE® RTV Clear Silicone	300 ml	19
495315	37523	LOCTITE® RTV Black Silicone	300 ml	19
495318	37525	LOCTITE® RTV Blue Silicone Gasket Maker	300 ml	25, 29
495536	37528	LOCTITE® RTV Red Silicone Gasket Maker	300 ml	25, 29

INDEX BY PART NUMBER

Item Number	Legacy Number	Product Name	Container Size	Page(s)
495538	37529	LOCTITE® RTV Red Silicone Gasket Maker	7.25 oz.	25, 29
495540	37531	LOCTITE® LocWeld™ Bonding Compound	2-1 oz. tubes	20
495541	37532	LOCTITE® Black Weatherstrip Adhesive	5 oz. tube	21
495545	37534	LOCTITE® Dielectric Tune-Up Grease	0.33 oz.	33
495549	37535	LOCTITE® Dielectric Tune-Up Grease	80 ml tube	33
495556	37539	LOCTITE® Anti-Seize Lubricant	1 oz. tube	31
495572	37544	LOCTITE® Gasket Sealant 2	3 oz. tube	27, 29
497091	37555	LOCTITE® Hi-Tack Gasket Sealant	9 fl. oz.	26, 29
500995	37562	LOCTITE® Anti-Seize Lubricant	1 lb. brushtop bottle	31
500997	37563	LOCTITE® Anti-Seize Lubricant	4 oz. brushtop bottle	31
501000	37565	LOCTITE® Anti-Seize Lubricant	8 oz. brushtop bottle	31
501001	37566	LOCTITE® Anti-Seize Lubricant	1 lb. brushtop bottle	31
502908	37580	LOCTITE® Rubberized Undercoating	16 oz. aerosol	34
502911	37583	LOCTITE® Copper Gasket Adhesive	9 oz. aerosol	27, 29
503049	37584	LOCTITE® Silicone Lubricant	13 oz. aerosol	30
503054	37585	LOCTITE® Penetrating Oil	12 oz. aerosol	30
504465	37613	LOCTITE® Windshield Repair Kit	0.17 oz.	16
504466	37614	LOCTITE® Blue Stick Threadlocker	19 g stick	4, 5, 7, 11
504467	37615	LOCTITE® Thread Sealant Stick	19 g stick	4, 5, 12, 13
504468	37616	LOCTITE® Copper Anti-Seize Stick	20 g stick	4, 5, 31
504469	37617	LOCTITE® Silver Anti-Seize Stick	20 g stick	4, 5, 31
506166	37643	LOCTITE® Blue Stick Threadlocker	9 g stick	5, 7, 11

Item Number	Legacy Number	Product Name	Container Size	Page(s)
511535	37700	LOCTITE® Red Stick Threadlocker	19 g stick	4, 5, 7, 11
511537	37701	LOCTITE® Red Stick Threadlocker	9 g stick	5, 7, 11
555336	38650	LOCTITE® Anti-Seize Lubricant	8 oz. brushtop bottle	31
555337	38651	LOCTITE® Press Fit Repair 660™	50 ml	14, 15
555338	38652	LOCTITE® Bearing Mount 620™	36 ml bottle	14, 15
555339	38653	LOCTITE® Threadlocker 222™	6 ml tube	7, 11
555352	38655	LOCTITE® Gasket Maker 515™	50 ml tube	26, 28
555353	38656	LOCTITE® Threadlocker 277™	36 ml bottle	9, 11
623856	38658	LOCTITE® Anti-Seize Lubricant	12 oz. aerosol	31
576507	38725	LOCTITE® Thread Treatment Sticks Kit	5 sticks	4
636095	39123	LOCTITE® QuickTite® Super Glue Gel	4 g bottle	19
640482	39150	LOCTITE® Bearing Mount Stick	9 g stick	5, 15
640807	39158	LOCTITE® Hi-Tack Gasket Dressing Stick	19 g stick	5, 26, 28
718808	40300	LOCTITE® Disc Brake Quiet Stick	19 g stick	5, 32
743914	40480	LOCTITE® Ready Gasket	190 ml	25, 29
782111	40669	LOCTITE® Yellow Weatherstrip Adhesive	5 oz.	21
230992	230992	LOCTITE® Super Glue Longneck Bottle	5 g	18
633877	633877	LOCTITE® Extend® Rust Neutralizer	10.25 oz. spray	34
1158514	–	LOCTITE® Head Bolt & Water	50 ml	13
1212164	–	LOCTITE® Insulating & Sealing Wrap	1" x 10 ft. roll	35
1252795	–	LOCTITE® Oil & Gas Resistant Adhesive Sealant	30 ml tube	21
1330799	–	LOCTITE® Threadlocker 243™	6 ml tube	8, 11

INDEX BY PART NUMBER

Item Number	Legacy Number	Product Name	Container Size	Page(s)
1330906	–	LOCTITE® Threadlocker 243™	36 ml tube	8, 11
1360694	–	LOCTITE® Vinyl, Fabric, & Repair Adhesive	1 oz. tube	19
1360784	–	LOCTITE® Stik 'N Seal® Extreme Conditions Contact Adhesive	0.58 oz.	20
1363118	–	LOCTITE® Epoxy Plastic Bonder	25 ml	17
1363589	–	LOCTITE® Super Glue Ultra Gel Control	4 g bottle	18
1365882	–	LOCTITE® Super Glue Professional	20 g bottle	18
1372603	–	LOCTITE® Blue Threadlocker Tape 249™	0.5" x 260" roll	7, 11
1381191	–	LOCTITE® Naval Jelly® Rust Dissolver	8 oz. bottle	34
1381192	–	LOCTITE® Extend® Rust Neutralizer	8 oz. bottle	34
1395391	–	LOCTITE® Epoxy Quick Set™	25 ml	17
1399967	–	LOCTITE® Super Glue Liquid	2 g tube	18
1434516	–	LOCTITE® CA Mix Nozzle, (5) pack	2.5 mm nozzle	16, 20
1525607	–	LOCTITE® Aviation Gasket Sealant	16 oz. brushtop bottle	27, 29
1533652	–	LOCTITE® Thread Sealant with PTFE	16 oz. brushtop bottle	13
1537776	–	LOCTITE® Hi-Tack Gasket Sealant	16 oz. brushtop bottle	26, 29
1540599	–	LOCTITE® Insulating & Sealing Wrap	1" x 10 ft. roll	35
1647358	–	LOCTITE® Super Glue Ultra Liquid Control	4 g	18
1777012	–	LOCTITE® Clover® Lapping & Grinding Compound 280 Grit	2 oz.	34
1807961	–	LOCTITE® 3092™ Adhesive	10 g syringe	20
1906103	–	LOCTITE® Synthetic Grease	10.1 oz. aerosol	33
1919324	–	LOCTITE® Marine Epoxy	0.85 fl. oz. syringe	21
1999556	–	LOCTITE® Marine Grade Anti-Seize	7 oz. brushtop tube	30

Item Number	Legacy Number	Product Name	Container Size	Page(s)
2016891	–	LOCTITE® PL Marine Adhesive	10 fl. oz. cartridge	21
2020627	–	LOCTITE® PL Marine Adhesive	3 fl. oz. tube	21
2093363	–	LOCTITE® RTV 5699™ Grey Silicone Gasket Maker	190 ml	24, 29
2093364	–	LOCTITE® RTV 587™ Blue Silicone Gasket Maker	190 ml	24, 29
2093365	–	LOCTITE® RTV Black Silicone	190 ml	19
2096059	–	LOCTITE® Gasket Maker 518™	50 ml tube	26, 28
2096063	–	LOCTITE® Gasket Maker 518™	300 ml	26, 28
2137678	–	LOCTITE® Power Grab	300 ml bottle	35
2203451	–	LOCTITE® Threadlocker 263™	6 ml tube	8, 11
2203452	–	LOCTITE® Gasket Maker 518™	6 ml tube	26, 28
2205310	–	LOCTITE® Threadlocker 263™	36 ml bottle	8, 11
2207527	–	LOCTITE® Ready Gasket	10.1 fl oz.	25, 29
2264448	–	LOCTITE® Universal Bonder 4070™	11 g cartridge	16
2267077	–	LOCTITE® Spray Adhesive Professional Performance	13.5 oz. aerosol	21
2301375	37485	LOCTITE® Bearing Mount 680™	36 ml bottle	14, 15
2343776	–	LOCTITE® Freeze & Release™	13.52 fl. oz. aerosol	33
2392164	–	LOCTITE® Gasket Maker 518	25 ml application pen	23, 26
2573869	–	LOCTITE® PC 4401™ Matte Additive	1 L bottle	35
2573885	–	LOCTITE® PC 4400™ Protective Coating	1 L bottle	35
2573973	–	LOCTITE® PC 4402™ Accelerator Additive	120 ml bottle	35
2573975	–	LOCTITE® PC 4400™ Protective Coating	3.8 L jug	35

Henkel Corporation
Engineering Adhesives
www.na.henkel-adhesives.com/aam
www.loctite.com

U.S.A.	Canada
Henkel Corporation	Henkel Canada Corporation
Engineering Adhesives	Engineering Adhesives
One Henkel Way	2515 Meadowpine Blvd.
Rocky Hill, Connecticut 06067	Mississauga, Ontario L5N 6C3
Tel: 1.800.LOCTITE (562.8483)	Tel: 1.800.263.5043 (within Canada)
Tel: 860.571.5100	Tel: 905.814.6511
Fax: 860.571.5465	Fax: 905.814.5391